

KR4096HN KR4168HN

TIME LAPSE VIDEO
CASSETTE RECORDER



OPERATION INSTRUCTIONS

Ultrak Corporate Headquarters:
1301 Waters Ridge Drive, Lewisville, TX 75057
(800)796-2288 • (972)353-6400 • FAX (972)353-6670





WARNING

RISK OF ELECTRIC SHOCK
DO NOT OPEN



WARNING: TO REDUCE THE RISK OF ELECTRIC SHOCK, DO NOT REMOVE COVER (OR BACK). NO USER-SERVICEABLE PARTS INSIDE. REFER SERVICING TO QUALIFIED SERVICE PERSONNEL.



AVERTISSEMENT

DANGER D'ÉLECTROCUTION
NE PAS OUVRIR



AVERTISSEMENT: POUR ÉLIMINER TOUT RISQUE D'ÉLECTROCUTION, NE PAS OUVRIR LE COUVERCLE (OU LA PARTIE ARRIÈRE). AUCUNE PIÈCE RÉPARABLE PAR L'UTILISATEUR NE SE TROUVE À L'INTÉRIEUR. POUR TOUTE INTERVENTION D'ENTRETIEN OU DE RÉPARATION SE CONFIER AUX TECHNICIENS QUALIFIÉS.

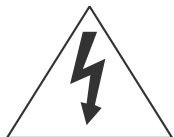

The lightning flash with arrowhead symbol, within an equilateral triangle, is intended to alert the user to the presence of uninsulated “dangerous voltage” within the product’s enclosure that may be of sufficient magnitude to constitute a risk of electric shock.



La flèche symbolisant l'éclair dans un triangle équilatéral a pour objet de tirer l'attention de l'utilisateur sur le fait, qu'il y a des “tensions dangereuses” non-isolées à l'intérieur de l'enceinte du produit qui peuvent être suffisamment importantes pour conduire au risque d'électrocution.



The exclamation point within an equilateral triangle is intended to alert the user to the presence of important operating and maintenance (servicing) instructions in the literature accompanying the appliance.



Le point d'exclamation au sein d'un triangle équilatéral a pour objet de tirer l'attention de l'utilisateur sur le fait qu'il y a des instructions de mise en service et d'entretien (de réparation) dans les fiches descriptives de l'appareil qui doivent obligatoirement être respectées.

WARNING:

TO PREVENT FIRE OR SHOCK HAZARD, DO NOT EXPOSE THIS APPLIANCE TO RAIN OR MOISTURE.

CAUTION:

TO PREVENT ELECTRIC SHOCK DO NOT USE THIS (POLARIZED) PLUG WITH AN EXTENSION CORD, RECEPTACLE OR OTHER OUTLET UNLESS THE BLADES CAN BE FULLY INSERTED TO PREVENT BLADE EXPOSURE.

AVERTISSEMENT:

AFIN D'ÉVITER TOUT RISQUE D'INCENDIE OU D'ÉLECTROCUTION, NE PAS EXPOSER CET APPAREIL À LA PLUIE NI À L'HUMIDITÉ.

ATTENTION:

POUR PRÉVENIR LES CHOCS ÉLECTRIQUES NE PAS UTILISER CETTE FICHE POLARISÉE AVEC UN PROLONGATEUR, UNE PRISE DE COURANT OU UNE AUTRE SORTIE DE COURANT, SAUF SI LES LAMES PEUVENT ÊTRE INSÉRÉES À FOND SANS EN LAISSER AUCUNE PARTIE À DÉCOUVERT.

Important Safeguards

Please read all these instructions carefully regarding your VCR before you begin operating it. Follow all warnings and instructions marked on the VCR.

1 Read Instructions

All the safety and operating instructions should be read before the product is operated.

2 Retain Instructions

The safety and operating instructions should be retained for future reference.

3 Heed Warnings

All warnings on the product and in the operating instructions should be adhered to.

4 Follow Instructions

All operating and use instructions should be followed.

5 Cleaning

Unplug this product from the wall outlet before cleaning. Do not use liquid cleaners or aerosol cleaners. Use a damp cloth for cleaning.

6 Attachments

Do not use attachments not recommended by the product manufacturer as they may cause hazards.

7 Water and Moisture

Do not use this product near water — for example, near a bath tub, wash bowl, kitchen sink, laundry tub, in a wet basement, or near a swimming pool, and the like.

8 Accessories

Do not place this product on an unstable cart, stand, tripod, bracket, or table. The product may fall, causing serious injury to a child or adult, and serious damage to the product. Use only with a cart, stand, tripod, bracket, or table recommended by the manufacturer, or sold with the product. Any mounting of the product should follow the manufacturer's instructions, and should use a mounting accessory recommended by the manufacturer.

- 9 A product and cart combination should be moved with care. Quick stops, excessive force, and uneven surfaces may cause the product and cart combination to overturn.



10 Ventilation

Slots and openings in the cabinet are provided for ventilation and to ensure reliable operation of the product and to protect it from overheating, and these openings must not be blocked or covered. The openings should never be blocked by placing the product on a bed, sofa, rug, or other similar surface. This product should not be placed in a built-in installation such as a bookcase or rack unless proper ventilation is provided or the manufacturer's instructions have been adhered to.

11 Power Sources

This product should be operated only from the type of power source indicated on the marking label. If you are not sure of the type of power supply to your home, consult your product dealer or local power company. For products intended to operate from battery power, or other sources, refer to the operating instructions.

12 Grounding or Polarization

This video product is equipped with a 3-wire grounding-type plug, a plug having a third (grounding) pin. This plug will only fit into a grounding-type power outlet. This is safety feature. If you are unable to insert the plug into the outlet, contact your electrician to replace your obsolete outlet. Do not defeat the safety purpose of the grounding-type plug.

13 Power-Cord Protection

Power-supply cords should be routed so that they are not likely to be walked on or pinched by items placed upon or against them, paying particular attention to cords at plugs, convenience receptacles, and the point where they exit from the product.

14 Lightning

For added protection for this product during a lightning storm, or when it is left unattended and unused for long periods of time, unplug it from the wall outlet and disconnect the antenna or cable system. This will prevent damage to the product due to lightning and power-line surges.

15 Overloading

Do not overload wall outlets, extension cords, or integral convenience receptacles as this can result in fire risk or electric shock.

16 Object and Liquid Entry

Never push objects of any kind into this product through openings as they may touch dangerous voltage points or short-out parts that could result in a fire or electric shock. Never spill liquid of any kind on the product.

17 Servicing

Do not attempt to service this product yourself as opening or removing covers may expose you to dangerous voltage or other hazards. Refer all servicing to qualified service personnel.

18 Damage Requiring Service

Unplug this product from the wall outlet and refer servicing to qualified service personnel under the following conditions:

- When the power-supply cord or plug is damaged.
- If liquid has been spilled, or objects have fallen into the product.
- If the product has been exposed to rain or water.
- If the product does not operate normally by following the operating instructions. Adjust only those controls that are covered by the operating instructions as an improper adjustment of other controls may result in damage and will often require extensive work by a qualified technician to restore the product to its normal operation.
- If the product has been dropped or damaged in any way.
- When the product exhibits a distinct change in performance – this indicates a need for service.

Important Safeguards (Cont.)

19 Replacement Parts

When replacement parts are required, be sure the service technician has used replacement parts specified by the manufacturer or have the same characteristics as the original part. Unauthorized substitutions may result in fire, electric shock or other hazards.

20 Safety Check

Upon completion of any service or repairs to this product, ask the service technician to perform safety checks to determine that the product is in proper operating condition.

21 Heat

The product should be situated away from heat sources such as radiators, heat registers, stoves, or other products (including amplifiers) that produce heat.

INFORMATION

This equipment has been tested and found to comply with the limits for a Class B digital device, pursuant to Part 15 of the FCC Rules. These limits are designed to provide reasonable protection against harmful interference in a residential installation. This equipment generates, uses, and can radiate radio frequency energy and, if not installed and used in accordance with the instructions, may cause harmful interference to radio communications. However, there is no guarantee that interference will not occur in a particular installation. If this equipment does cause harmful interference to radio or television reception, which can be determined by turning the equipment off and on, try to correct the interference by one or more of these measures:

- Reorient or relocate the receiving antenna
- Increase the separation between the equipment and receiver
- Connect the equipment into an outlet on a different circuit than the receiver is connected
- Consult the dealer or an experienced radio/TV technician for help

Changes or modifications not expressly approved by the party responsible for compliance could void the user's authority to operate the equipment.

INFORMATION

This Class B digital apparatus complies with Canadian ICES-003.

INFORMATION

Cet appareil numérique de la classe B est conforme à la norme NMB-003 du Canada.

Caution and Care

CONDENSATION IS THE ENEMY OF VIDEO RECORDERS

■ WHAT IS CONDENSATION?

1. When a very cold drink is poured into a glass, the water droplets which form on the outer surface of the glass are an example of condensation.
2. If the VCR is exposed to a rapid increase in temperature (such as warming it in a cold room or after transporting it from a cold location to a warm one) condensation may form on the tape transport mechanism inside the VCR. By heating the inside of the VCR, it can dry up the moisture and prevent damage to the VCR or video tape from condensation. To do this, plug the VCR in and switch the VCR POWER to ON. Leave the VCR on for at least 2 hours before using it for recording or playback.

■ CONDENSATION IS LIKELY TO OCCUR WHEN:

1. The VCR is moved inside from outdoors or from a cold room to a warm one.
2. A cold room is heated quickly.
3. Humidity is high.

Note

- Avoid using the VCR where cold air (e.g., from an air conditioner) will blow directly on it.

Never place anything containing water on top of the VCR (e.g., vases, cups, etc.).

Heavy objects (e.g., TV) should never be placed on the VCR

NEVER TOUCH OR INSERT ANY OBJECT INSIDE THE VCR

Touching the inside of the cabinet or inserting foreign objects of any kind not only creates a safety hazard but can also cause extensive damage.

PROTECT THE POWER CORD

Damage to the power cord may cause fire or shock hazard. When unplugging the power cord, hold it by the plug only and pull out carefully.

UNPLUG THE POWER CORD DURING A LONG ABSENCE

Turn the power off and unplug the power cord during a long absence.

MAINTAIN GOOD VENTILATION

Do not obstruct the ventilation holes on the VCR. For maximum ventilation, place the unit on a hard level surface only, and ensure it is not covered during use.

WHEN NOT IN USE

When you finish operating the VCR, always unload the cassette and turn the VCR off.

CABINET CARE

Never use petroleum-based cleaners. Clean with a soft cloth moistened with soap and water and wipe dry. PVC cables or leads should not be left in contact with the cabinet surface for long periods.

INSTALLATION LOCATION

For excellent performance and lasting reliability, install in a location that is:

1. Well ventilated, out of direct sunlight, and away from direct heat.
2. A solid, vibration-free surface.
3. Free from high humidity or excessive dust and away from magnetic fields.

Note Never move the VCR without first removing the tape.

CARE OF THE VIDEO CASSETTE TAPES

- Avoid vibration or shock.
- Do not place near a strong magnetic field (e.g., a motor, transformer, or magnet).
- Never place or store in direct sunlight.
- Avoid dusty places.
- Place the cassette in its case and store vertically.
- Never store tape in high humidity.



WARNING:

The included power cord is used for 120 V, 60 Hz.

Never connect any outlet or power supply having a different voltage or frequency.

Features

Up to 96 hours (for 96-hour model) or 168 hours (for 168-hour model) of recording: in addition to regular 6-hour recording mode, it has 18, 30, 48, 72 and 96-hour (for 96-hour model) or 18, 30, 48, 72, 96, 120 and 168-hour (for 168-hour model) time lapse modes (using T-120 tape).

Audio Recording

High Resolution and Image Quality

Remote Operation by PC via RS-232C

Automatic Head Cleaning

Easy Menu Setting on Screen

Easy Cueing with Alarm Recording

One Button Recording Check

All or Part Front Panel Lock

Protection Against Power Failure

Variety of Search Functions

Recording Options for Various Needs

- Daily/weekly/holiday timer recording
- Alarm recording
- Series recording
- Remote recording
- Repeat recording
- One shot/Interval recording
- Synchronous recording

Special Playback Features

- Still picture
- Speed search using shuttle ring
- Frame-by-frame and field-by-field playback using jog dial

Contents

Important Safeguards	ii - iii
Introduction	
Caution and Care	1
Features	2
Controls and Functions	3
Front View	3
Fluorescent Display	4
Rear View	5
Basic Functions	
Loading/Unloading a Tape	6
Manual Recording	7
Playback	8
Adjusting the Clock	9
Advanced Functions	
Recording Techniques	10
Timer Recording	10
Alarm Recording	11
Emergency Recording	12
Series Recording	12
Remote Recording	13
Repeat Recording	13
One Shot/Interval Recording	13
Synchronous Recording	14
Additional Features	15
Memory Backup in Case of Power Failure	15
After a Power Failure	15
Displaying/Clearing the Power Loss List	15
Displaying/Clearing the Alarm List	15
Tape Usage and Elapsed Time of VCR	16
Lock Function	16
Special Effects Playback	16
Still Picture	16
Shuttle Ring	16
Shuttle Hold	16
Direct Shuttle Ring	16
Frame or Field Playback	17
Adjustment during Playback	17
Tracking Adjustment	17
Vertical Adjustment	17
Searching Techniques	18
Counter Memory Stop	18
Skip Search	18
Index Search	18
Time Date Search	19

Using with Personal Computer	20
Configuring the Time Lapse VCR	20
RS-232C Setting	20
Connecting to a Personal Computer	20
Commands from Personal Computer	21
Commands and Responses	22

Installation

Connections for Various Functions	26
Connecting with CCTV Camera, Monitor, and Sensor	26
Alarm Recording Connection	26
Series Recording Connection	27
Remote Recording Connection	27
Synchronous Recording Connection	27
Connection for External Time Clock Adjustment	27
Setting the Clock	28
Setting the Menus	29
Menu Chart	29
Language Selection	30
Main Menu	30
Display	30
Timer Program	30
Recording Set Up	30
Rear Terminal	31
Maintenance	31
First Time Set Up	32
RS-232C	32

Others

Remote Controller (Optional)	33
Before Calling for Service	34
Warning Display	36
Control Input/Output Signals and Circuit	37
Specifications	38

Accessories

- 1 User's manual
- 1 Power cord
- 1 Warranty card

Controls and Functions

Front View

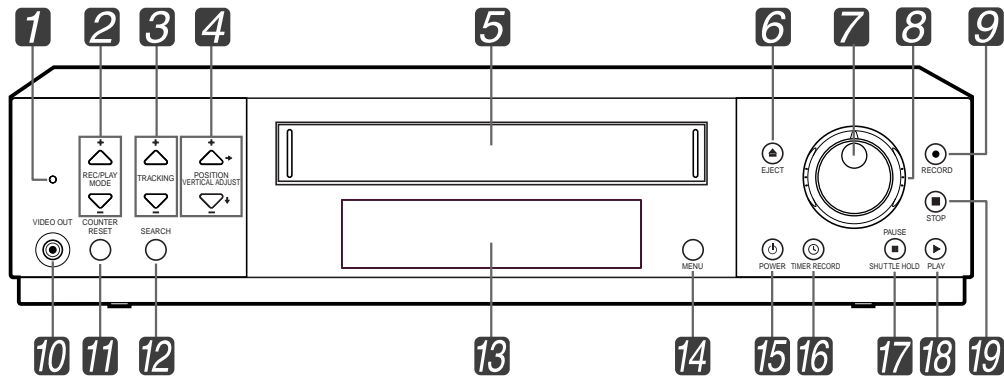

1 Lock button

Press to lock the VCR into the current mode.

2 REC/PLAY MODE buttons

Press to select the recording or playback speed.

3 TRACKING buttons

Press to reduce/eliminate the noise during playback, slow playback, etc.

4 POSITION/VERTICAL ADJUST buttons

- When the day and present time display is shown on the monitor screen, press the top button to move the display to the right-forward or bottom button to move it down. During an alarm recording or if a warning is displayed on screen, the day and present time display cannot be moved.
- If screen images are blurred vertically during still picture or special effects playback, press to reduce/eliminate the picture vibration.

5 Cassette Loading Slot

Cassette is inserted in this slot for loading.

6 EJECT button

Press to remove the cassette.

7 JOG dial

Use to forward/reverse a tape frame-by-frame (field-by-field) or to set the menus.

8 SHUTTLE ring

When the VCR is in stop mode, turn to the right to forward a tape or to the left to rewind. Also, use for special effects playback or to set the menus.

9 RECORD button

Press to begin recording.

10 VIDEO OUT connector

Output connector for video signal (RCA pin). Connect a monitor here.

11 COUNTER RESET button

Press to reset the counter to "00000".

12 SEARCH button

Press to display the <SEARCH FUNCTION> menu.

13 Fluorescent Display

 next page

14 MENU button

When the VCR is turned on, press to display the <MAIN MENU>. Press again to exit the menu. When the VCR is turned off, press this button for more than 3 seconds to adjust the VCR's time and date.

15 POWER button

Press to turn the VCR POWER on or off.

16 TIMER RECORD button

Press to start timer recording, when you have programmed your VCR to record.

17 PAUSE/SHUTTLE HOLD button

During recording, press to stop the tape movement temporarily. Press again to continue the recording. During playback, press to obtain a still picture. During special effects playback using SHUTTLE ring, press to fix the playback speed.

18 PLAY button

When the VCR is in stop mode, press to playback a previously recorded tape. During recording, press for more than 1.5 seconds to check recording function.

19 STOP button

Press to stop all tape-related functions.

Controls and Functions (Cont.)

Fluorescent Display

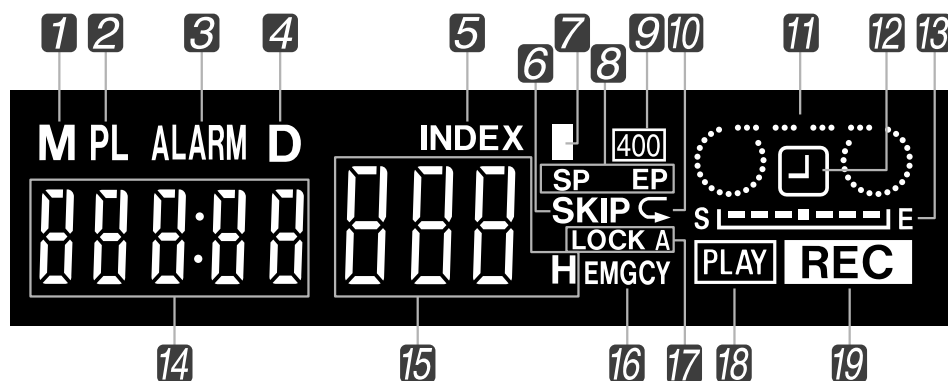

1 M (Counter Memory Stop/Month) indicator

Illuminates during the counter memory stop.
Also, illuminates when the month (of time and date) is being entered via the front panel.

2 PL (Power Loss) indicator

Illuminates when the VCR is turned on after a power failure occurs during recording.

3 ALARM (Alarm Recording) indicator

Flashes during alarm recording and stays on when the alarm recording is finished.

4 D (Time Date Search/Day) indicator

Illuminates during the time date search.
Also, illuminates when the day (of time and date) is being entered via the front panel.

5 INDEX (Index Search) indicator

Flashes when recording an index signal and illuminates during the index number setup and the index search. (Index number is shown on the Recording and Playback Mode display.)

6 SKIP (Skip Search) indicator

Illuminates during the skip search.

7 ■ (Daylight Saving Time) indicator

Illuminates when "DAYLIGHT SAVINGS" is set to "ON".

8 SP, EP (Tape Speed) indicator

Indicates the tape speed.
SP is standard play; EP is extended play.

9 400 (Super Resolution) indicator

Illuminates during the recording, during the playback using a tape recorded in Super Resolution mode, and when a tape recorded in Super Resolution mode is inserted into the VCR, providing "SUPER RESOLUTION" in "RECORDING SET UP" menu is set to "ON."

10 ↺ (Repeat) indicator

Illuminates when "TAPE END" in "FIRST TIME SET UP" menu is set to "REPEAT" or "ALARM•PROT."

11 ○○○ (Cassette Status) indicator

Illuminates when a tape is inserted.

12 □ (Timer Recording) indicator

Illuminates when the VCR is in stand-by for timer recording or during timer recording.

13 S-----E (Tape Remaining) indicator

Indicates the position on the tape. S indicates the Start of the tape and E indicates the End of the tape.

14 Counter/Clock display

While the VCR is turned on, indicates the relative position on the tape. (The Counter stops counting where no recording is made on the tape.) When it is off, (when set) the clock (24-hour format) is shown.

15 Recording and Playback Mode/Index Number display

Displays the number corresponding to a selected recording or playback mode. The mode shown here varies by the "TAPE LENGTH" setting (T-120 or T-160) setting in "FIRST TIME SET UP" menu. Also, displays the index number during the index number setup and the index search.

16 EMGCY (Emergency Recording) indicator

Illuminates when "EMERGENCY REC" in "RECORDING SET UP" menu is set to "ON."

17 Lock/Lock All indicator

LOCK : illuminates when all buttons (except RECORD button and EJECT button) are locked.
LOCK A : illuminates when all buttons are locked.

18 PLAY (Playback) indicator

Illuminates during playback.

19 REC (Recording) indicator

Illuminates during recording.

Rear View

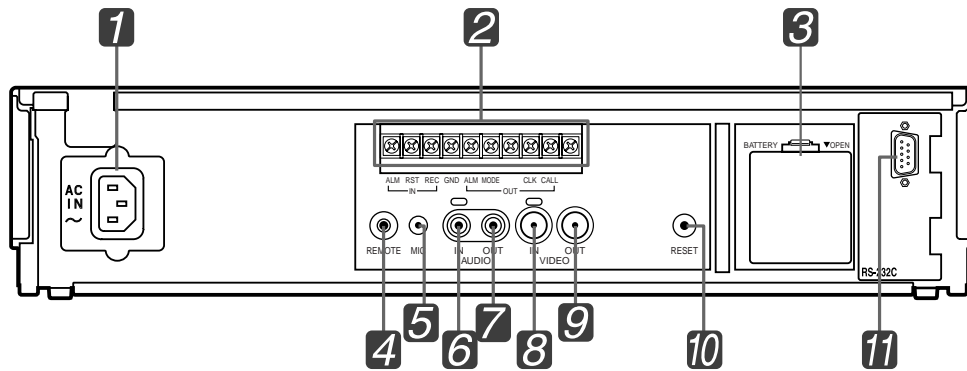

Warning:

The included power cord is used for 120 V, 60 Hz.
Never connect to any outlet or power supply having a different voltage or frequency.

Note

Ensure the power cord is not plugged into the outlet before connecting to any rear terminals.

1 AC power socket

This socket connects to the power cord. Insert the cord firmly.

2 Input terminals

ALM IN

Use for alarm recording. The alarm sensor is connected here.

RST IN

Use to stop alarm recording.

- When "ALARM REC DURATION" in "RECORDING SET UP" menu is set to "MAN1," the alarm recording stops when a signal is input to this terminal. The alarm reset switch is connected here.
- When set to other than "MAN1," it can be used to adjust the VCR's clock.

REC IN

Use to start/stop recording or for series recording.

GND

When a lead connected to other terminals requires a ground, connect the ground lead here.

Output terminals

ALM OUT

Use to indicate an alarm recording to an external alarm.

MODE OUT

Use to indicate the VCR's mode of operation.

- When "MODE OUT" in "REAR TERMINAL" menu is set to "CLOCK ADJ," the clock of all connected VCRs can be adjusted. (☞ page 28)

CLK OUT

Use to control an external camera switcher.

CALL OUT

Use to indicate when a tape reaches its end during recording or if there has been a problem during recording.

3 Battery Box

Battery is stored here.

Note

- This VCR contains a special battery. Consult your dealer to replace it.

4 REMOTE jack

Remote control is possible by connecting the remote control unit (R-9100) here. (☞ page 33)

5 MIC IN jack

Input jack for a microphone rated at 600Ω impedance.

6 AUDIO IN connector

Audio input connector (RCA pin).

7 AUDIO OUT connector

Audio output connector (RCA pin).

8 VIDEO IN connector

Input connector for video signal (BNC connector). Connect cameras here.

9 VIDEO OUT connector

Output connector for video signal (BNC connector). Connect a monitor here.

10 RESET button

(☞ page 38)

11 RS-232C terminal (D-SUB 9pin)

Input terminal to connect with a personal computer via RS-232C cross cable.

For the rating of each connector at the rear panel of VCR, (☞ page 37).

Loading/Unloading a Tape

Tapes can be loaded into your VCR as long as the VCR is plugged into an outlet. Even if the VCR is turned off, loading a tape will automatically cause it to turn on. Use only video cassette tapes marked **VHS** or **S-VHS**.

Important notice:

- Use high grade (HG) tapes for super resolution recording. We recommend to use S-VHS tapes for super resolution recording at L18H-L40H mode.
- It is recommended to use T-120 tape. Do not use tapes longer than T-160.

Loading

1. Insert the tape into the cassette slot by holding it so that the long narrow edge with the contents label faces towards you.
 - The Cassette Status indicator illuminates on the fluorescent display when the tape is inserted.

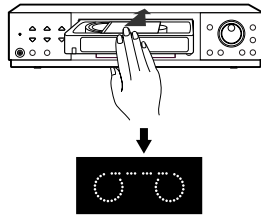

Note

- Your VCR has a protection circuit which will eject the tape if it is loaded improperly. If the VCR ejects the tape, remove it completely and check that the long narrow edge with the contents label is facing towards you, and the clear plastic window that shows the video tape is facing upwards. Wait a few seconds, and try inserting the tape again.

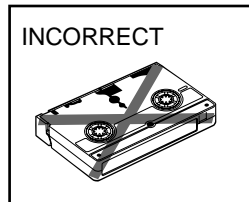

Preventing accidental erase

Tapes come with an erase prevention tab which, when removed, prevents the tape's contents from being erased or recorded over. If the tape you insert in the VCR has the erase prevention tab removed, your VCR will automatically eject it if you attempt to record on it.

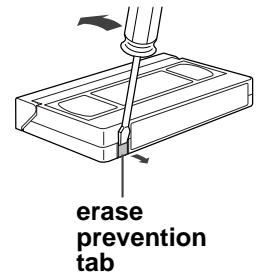

Note

- We recommend that you take any broken or torn tapes to a professional for repair. The adhesives on many common types of tape could damage the head of your VCR.

Recommended number of tape use

It is recommended that the cassette tape be replaced with a new one depending on the recording time mode and type of tape used. Providing TAPE LENGTH of FIRST TIME SET UP menu is set to the same type the tape you use.

For 96-hour model:

In case of T-120 setting

Recording time mode	Number of tape use
6H	50
L18H	35
L30H	20
48H	20
72H	15
96H	15
0H	1

In case of T-160 setting

Recording time mode	Number of tape use
8H	45
L24H	30
L40H	10
64H	5
96H	3
128H	3
0H	1

For 168-hour model:

In case of T-120 setting

Recording time mode	Number of tape use
6H	50
L18H	35
L30H	20
48H	20
72H	15
96H	15
120H	10
168H	8
0H	1

In case of T-160 setting

Recording time mode	Number of tape use
8H	45
L24H	30
L40H	10
64H	5
96H	3
128H	3
160H	2
224H	1
0H	1

Info.

- The VCR automatically turns on when the tape is loaded, **AUTO POWER ON**.
- The VCR automatically plays back the tape if the erase prevention tab is removed, **AUTO PLAY**.
- You cannot insert a tape when all of the VCR's buttons are locked and the Lock All indicator (LOCK A) is illuminating.

Unloading

1. Press **EJECT** button on the front panel of the VCR.
2. Remove the tape.

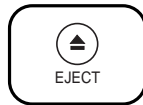

Note

- When ejecting the tape during recording, press **STOP** button once to stop recording and then press **EJECT** button to unload the tape.
- You cannot eject a tape when all of the VCR's buttons are locked and the Lock All indicator (LOCK A) is illuminating.

Info.

- The VCR will eject a tape even if the power to the VCR is turned off (as long as the VCR is plugged into an outlet), **POWER OFF EJECT**.

Manual Recording

1. Turn on the VCR and peripheral devices.

2. Load a tape with an erase prevention tab intact.

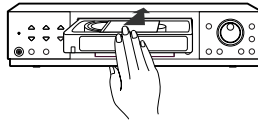

Steps 3 to 7 for activating Super Resolution recording mode.

3. Press **MENU** button.

- **<MAIN MENU>** appears.

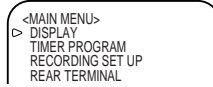

4. Turn **JOG** to select **RECORDING SET UP** and turn **SHUTTLE** to the right.

- **<RECORDING SET UP>** menu appears.

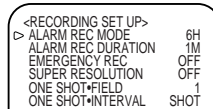

5. Turn **JOG** to select **SUPER RESOLUTION** and turn **SHUTTLE** to the right.

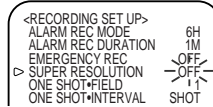

6. Turn **JOG** to select **ON** and turn **SHUTTLE** to the right.

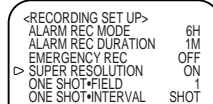

7. Press **MENU** button.

- The day and present time display appears on screen.

8. Press **REC/PLAY MODE** button to select the desired recording mode.

- ➔ Refer to [Recording/playback time](#) on the next column for the actual recording/playback time .

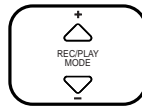

9. Press **RECORD** button to begin recording.



10. Press **STOP** button to stop recording.

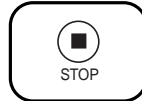

Note

- If the tape you insert in your VCR has the erase prevention tab removed, your VCR will automatically eject it if you attempt to record on it.
- The **RECORD** button will not function unless a tape is in stop or pause mode.
- A tape recorded by this VCR may not be played back correctly by another VCR.

Info.

- Press the **PAUSE** button to momentarily stop recording. Press it again to resume recording. To protect the tape, the pause mode is automatically cancelled after about 5 minutes.

Page 32 for the VCR's function when the tape reaches its end during recording.

Recording/playback time

For 96-hour model:

(hours : minutes)

Recording time mode	TAPE LENGTH setting	T-120	Recording time mode	TAPE LENGTH setting	T-160
2H*		2:00	2H*		2:40
6H		6:00	8H		8:00
L18H		18:00	L24H		24:00
L30H		30:00	L40H		40:00
48H		54:00	64H		72:00
72H		78:00	96H		104:00
96H		102:00	128H		136:00

* is for playback only

For 168-hour model:

(hours : minutes)

Recording time mode	TAPE LENGTH setting	T-120	Recording time mode	TAPE LENGTH setting	T-160
2H*		2:00	2H*		2:40
6H		6:00	8H		8:00
L18H		18:00	L24H		24:00
L30H		30:00	L40H		40:00
48H		54:00	64H		72:00
72H		78:00	96H		104:00
96H		102:00	128H		136:00
120H		126:00	160H		168:00
168H		174:00	224H		232:00

* is for playback only

Audio recording/playback

The 2H (playback only), 6H, 8H modes, and the modes with the letter "L" (L18H, L24H, L30H, and L40H) are for audio recording and playback on the linear track.

Note

- Audio will not be recorded if cables for audio are not connected to the AUDIO IN connector or the microphone is not connected to the MIC IN jack.
- The longer the recording mode is set, the worse the sound quality gets. In L30H or L40H mode, the sound quality is of the degree that the speaking voice can be heard.

Recording Check Function

When the VCR is recording, press the **PLAY** button for more than 1.5 seconds and then release. The tape will rewind a little and then playback the recording just made. When the tape reaches the position where the **PLAY** button was pressed, the VCR starts recording again.

Playback

1. Turn on the VCR and peripheral devices.

2. Load a pre-recorded tape.



3. Repeat steps 3 to 7 in Manual Recording for activating Super Resolution playback mode.

4. Press **REC/PLAY MODE** button to select the desired playback mode.

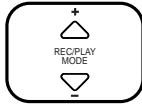

5. Press **PLAY** button to start playback.

- If noise occurs during playback, adjust the tracking, page 17.



6. Press **STOP** button to stop playback.

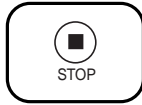

Info.

- VCR automatically plays back the tape on which the erase prevention tab was removed, **AUTO PLAY**.

Note

- Playback mode for 96-hour model**
When TAPE LENGTH in FIRST TIME SET UP menu is set to T-120, the playback mode is switched in the order of 6H → L18H → L30H → 48H → 72H → 96H → 0H → 6H... (for a tape recorded in the recording mode longer than 6H mode).
When TAPE LENGTH in FIRST TIME SET UP menu is set to T-160, the playback mode is switched in the order of 8H → L24H → L40H → 64H → 96H → 128H → 0H → 8H... (for a tape recorded in the recording mode longer than 8H mode).
 - A tape recorded in SP mode using other VCR can only be played back in 2H mode.
- Playback mode for 168-hour model**
When TAPE LENGTH in FIRST TIME SET UP menu is set to T-120, the playback mode is switched in the order of 6H → L18H → L30H → 48H → 72H → 96H → 120H → 168H → 0H → 6H... (for a tape recorded in the recording mode longer than 6H mode).
When TAPE LENGTH in FIRST TIME SET UP menu is set to T-160, the playback mode is switched in the order of 8H → L24H → L40H → 64H → 96H → 128H → 160H → 224H → 0H → 8H... (for a tape recorded in the recording mode longer than 8H mode).
 - A tape recorded in SP mode using other VCR can only be played back in 2H mode.
- Picture jitter or noise may occur when the tape is played back in L18H, L24H, L30H, or L40H mode even if the tape was recorded in its respective mode.
- When a pre-recorded tape is used for recording, the colored noise may appear on the beginning of the playback picture.
- There is normal sound playback only when a tape recorded in 6H, 8H, L18H, L24H, L30H, or L40H mode is played back in its respective mode.

page 18-19 to find a picture you wish to view.

When the tape reaches its end during playback/fast forwarding

VCR's function varies by the setting of TAPE END in the FIRST TIME SET UP menu.

VCR's function TAPE END setting	Playback	Fast Forward
STOP or REWIND	Stop	Stop
REPEAT or ALARM•PROT	VCR automatically rewinds to the beginning of the tape and stops.	Stop

page 32 for TAPE END setting.

Rewinding a tape

While the tape is stopped, turn **SHUTTLE** to the left.

To stop rewinding, press **STOP** button.

Fast forwarding a tape

While the tape is stopped, turn **SHUTTLE** to the right.

To stop fast forwarding, press **STOP** button.

Info.

- The fast forward/rewind time of a T-120 tape is approximately 2 minutes; however, the time varies by the type of tape you use.

Audio playback and picture quality

Playback mode	2H-8H	L18H-L40H	48H-224H
Audio playback	Very good	Good	Not available
Picture Quality	Very good	Good	Good

Adjusting the Clock

You can adjust the VCR's clock from the front panel, even though the VCR is turned off. This function lets you set the information in the order of time, month, day, and year. The hour time is entered twice. This is due to daylight saving time.

Example : Setting the day and present time to 10:38 a.m., 11 December 2002.

1. When the VCR and peripheral devices are turned off, press **MENU** button for more than 3 seconds.

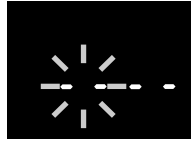

- The hour digits of the clock on the fluorescent display starts flashing.

2. Turn **JOG** to set the hour digits.

- ⇒ When the flashing item is same as the current time, turn **SHUTTLE** without turning **JOG**.



3. Turn **SHUTTLE** to the right to make the 10-minute digit flash and turn **JOG** to adjust.

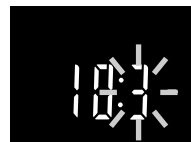

4. Turn **SHUTTLE** to the right to make the 1-minute digit flash and turn **JOG** to adjust.

- ⇒ To finish the clock adjustment now, press **MENU** button for more than 3 seconds.

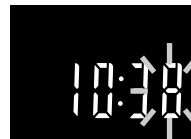

5. Turn **SHUTTLE** to the right to make the month digits flash and turn **JOG** to adjust.

- The Month indicator (**M**) illuminates.



6. Turn **SHUTTLE** to the right to make the day digits flash and turn **JOG** to adjust.

- The Day indicator (**D**) illuminates.

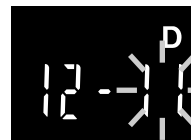

7. Turn **SHUTTLE** to the right to make the year digits flash and turn **JOG** to adjust.



8. Turn **SHUTTLE** to the right.

- The VCR's clock is now set.

9. Repeat steps 1 and 2 and turn **SHUTTLE** to the left to exit after the hour mark is entered the second time.

Note

- Time and Date information can also be entered via the Menu System (FIRST TIME SETUP/TIME DATE ADJUST).

When adjusting the clock to the exact second

Set the clock as described above, but set 1-minute digit to one or two minutes ahead of the reference time being used. After step 7 above, when reference time reaches 00 second of the minute you have chosen, turn **SHUTTLE** to the right. The VCR's clock now corresponds to the reference time to the nearest second.

Info.

Use of **JOG** dial and **SHUTTLE** ring for menu setting

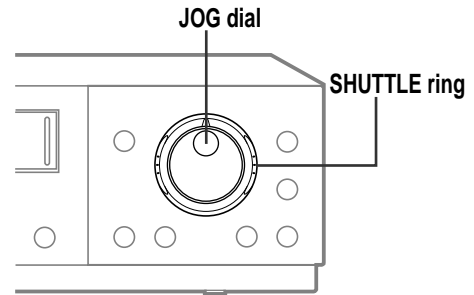

JOG dial

- Use **JOG** by placing a finger in the indent and turning.
- Turning **JOG** to the right moves the selection forward. Turning it to the left moves the selection back.
- If the selection is not flashing, turn **JOG** to the right to move the cursor (▷) down one position then to the left to move back to your selection.

SHUTTLE ring

- If you turn **SHUTTLE** to the right/left end and release it, **SHUTTLE** comes back to the center position automatically.
- Navigate to the next menu layer by turning **SHUTTLE** to the right. Return to the previous menu layer by turning **SHUTTLE** to the left.

Recording Techniques

Timer Recording

Accurately preset the day and present time before timer programming. (☞ page 9 or 28)

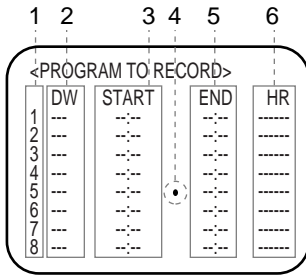

For 96-hour model:

T-120	6EP → L18EP → L30EP → 48EP → 72EP → 96EP → 0EP → SKIP
T-160	8EP → L24EP → L40EP → 64EP → 96EP → 128EP → 0EP → SKIP

For 168-hour model:

T-120	6EP → L18EP → L30EP → 48EP → 72EP → 96EP → 120EP → 168EP → 0EP → SKIP
T-160	8EP → L24EP → L40EP → 64EP → 96EP → 128EP → 160EP → 224EP → 0EP → SKIP

- 1) Program number
Up to 8 programs can be set.
- 2) Day of the week display
 - Display **HLD** to apply HOLIDAY SET UP setting (☞ next page).
 - Display **SPL** to apply SPECIAL DW setting (☞ next page).
 - Display **DAY** to record at the programmed time everyday.
- 3) Recording start-time
- 4) Next day indicator (•)
Recording continues to the following day.
- 5) Recording end-time
- 6) Recording mode
 - Recording mode varies by the TAPE LENGTH setting of FIRST TIME SET UP menu. See the table shown to the left.
 - Timer recording will not be performed when set to **SKIP**.

Info. • Time is displayed in 24-hour format.

Example: Setting number 2 to L18H mode timer recording from 12:00 to 15:00 every Tuesday.

1. Press **MENU** button.
 - **<MAIN MENU>** appears.
2. Turn **JOG** to select **TIMER PROGRAM** and turn **SHUTTLE** to the right.
 - **<TIMER PROGRAM>** menu appears.
3. When the cursor (▷) is next to **PROGRAM TO RECORD**, turn **SHUTTLE** to the right.
 - **<PROGRAM TO RECORD>** menu appears.
4. Turn **JOG** to select the program number and turn **SHUTTLE** to the right to select.
5. In the **DW** column, turn **JOG** to select the Day of the Week. Turn **SHUTTLE** to the right to select.
6. In the **START** column, turn **JOG** to select the *hour* digits of the start time. Turn **SHUTTLE** to the right when done.
 - ☞ Set the *10-minute* digit and *1-minute* digit in a similar fashion.
7. In the **END** column, turn **JOG** to select the *hour* digits of the end time. Turn **SHUTTLE** to the right when done.
 - ☞ Set the *10-minute* digit and *1-minute* digit in a similar fashion.
8. In the **HR** column, turn **JOG** to select the RECORDING mode.

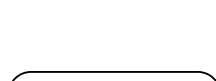
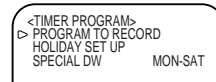
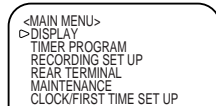

Setup step 9 to make recording while the REC IN terminal is grounded. If not, go to step 10.

9. Press **MENU** button.
 - The program you are currently setting is highlighted.
 - Press **MENU** button again to cancel.
10. Turn **SHUTTLE** to the right when done. (Cursor flashing will stop.)
 - If the program has not been set completely, the **DW** column will continue to flash.
 - ☞ Repeat steps 4 to 10 to set 2 or more programs at once.
11. Press **MENU** button.
 - The day and present time display appears on screen.
12. Press **TIMER RECORD** button.
 - The VCR is turned off and the Timer Recording indicator (☐) illuminates on the fluorescent display.
 - ☞ When **TIMER RECORD** button is pressed during the programmed period, the VCR starts recording immediately.



Info.

When the Timer Recording indicator (☐) starts flashing, check for the following conditions:

- a) A tape is not inserted.
 - b) A tape without erase prevention tab is inserted.
 - c) Day and present time have not been set.
 - d) Timer program has not been set.
 - e) Menu item has been set (flashing).
- Remedy –
1. Press **TIMER RECORD** button to turn off the Timer Recording indicator (☐).
 2. a) Insert a tape.
b) Insert a tape with erasure prevention tab intact.
c) Set the day and present time (☞ page 9 or 28)
d) Confirm the program.
e) Turn **SHUTTLE** to the right to stop flashing.
 3. Press **TIMER RECORD** button to turn on the Timer Recording indicator.

Info.

- To erase a program:
 - Select the program number you wish to erase, turn **SHUTTLE** to the right (**DW** column flashes), and then turn **SHUTTLE** to the left.

Holiday set up

Up to 20 days per year can be set for Holiday for when the timer recording will be performed; or if HR in PROGRAM TO RECORD menu is set to SKIP, the timer recording will not be performed during the programmed period.

- Display **<TIMER PROGRAM>** menu.
- Turn **JOG** to select **HOLIDAY SET UP** and turn **SHUTTLE** to the right.
 - <HOLIDAY SET UP>** menu appears.
- Turn **JOG** to move the cursor (▷) and turn **SHUTTLE** to the right.
 - Each time **JOG** is turned to the right, the cursor moves towards right-forward direction.
- Turn **JOG** to select the month you want, and turn **SHUTTLE** to the right.
- Turn **JOG** to select the day you want, and turn **SHUTTLE** to the right.
 - ⇒ Repeat steps 3 to 5 to set 2 or more days at once.
- Press **MENU** button.
 - The day and present time display appears on screen.

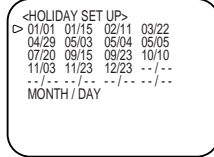

Info.

- To erase the pre-set month and day, turn **SHUTTLE** to the left while the month item is flashing.

Special day of the week

Set the recording period by specifying the start and end day of the week for timer recording.

- Display **<TIMER PROGRAM>** menu.
- Turn **JOG** to select **SPECIAL DW** and turn **SHUTTLE** to the right.
- Turn **JOG** to set the start and end day of the week, and turn **SHUTTLE** to the right.
- Press **MENU** button.
 - The day and present time display appears on screen.

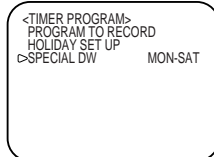

Note

- Start day of the week and end day of the week cannot be identical.

When the recording period of 2 or more programs are overlapped

The VCR always gives priority to the higher-numbered program.

Note

- To make sure that the HOLIDAY SET UP setting is applied correctly, set a timer program with **HLD** in **DW** column to the higher-numbered program.

Alarm Recording

If an alarm occurs, the VCR switches to alarm recording.

Example
When ALARM REC MODE is set to L30H and ALARM REC DURATION is 10 min.

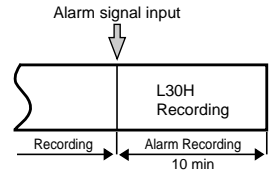

page 26 for alarm recording connection.

- Press **MENU** button.
 - <MAIN MENU>** appears.
- Turn **JOG** to select **RECORDING SET UP** and turn **SHUTTLE** to the right.
 - <RECORDING SET UP>** menu appears.
- When the cursor (▷) is next to **ALARM REC MODE**, turn **SHUTTLE** to the right.
- Turn **JOG** to set the alarm recording mode you want and turn **SHUTTLE** to the right.
- Turn **JOG** to select **ALARM REC DURATION** and turn **SHUTTLE** to the right.
- Turn **JOG** to set the alarm recording duration you want and turn **SHUTTLE** to the right.
 - When set to **MAN 1**, alarm recording continues until RST IN terminal is grounded.
 - When set to **MAN 2**, alarm recording continues while ALM IN terminal is grounded.
- Press **MENU** button.
 - The day and present time display appears on screen.

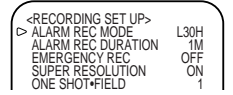
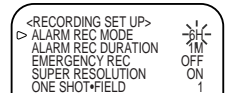
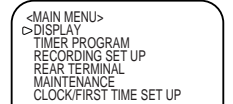

Info.

- The index signal is automatically recorded when an alarm recording begins. (The Index indicator (**INDEX**) flashes on the fluorescent display).
- Even if an alarm recording is proceeding, the new alarm recording starts when the next alarm signal is input. (While an index signal is being recorded and then the next alarm signal is input, the second signal may not be detected during skip or index search.)
- An alarm recording continues till its end during timer recording, even if the timer recording end-time is reached.
- An alarm recording will be cancelled if the tape reaches its end.
- If the interval between two alarm recording start-times is too short, the skip or index search may not function correctly. (⇒ for the minimum interval between two alarm recording start-times, go to page 18.)

Recording Techniques (Cont.)

Emergency Recording

The VCR automatically starts an alarm recording when an alarm signal is input even if the VCR is in stop mode, turned off, or in stand-by for timer recording. After an emergency recording, the VCR automatically returns to its original state.

- After step 6 of **Alarm Recording**, turn **JOG** to select **EMERGENCY REC** and turn **SHUTTLE** to the right.
- Turn **JOG** to select **ON** and turn **SHUTTLE** to the right.
 - The Emergency Recording indicator (EMGCY) illuminates on the fluorescent display.

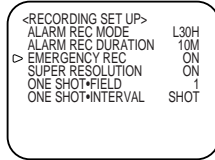

Display during alarm recording

- During the alarm recording, the alarm recording counter will automatically be displayed on screen if DISPLAY MODE (page 30) is set to 1, 2, or 3.
- The Alarm Recording indicator (ALARM) on the fluorescent display flashes during alarm recording and stays on when the alarm recording is finished.
- The alarm recording counter shows up to 9999 alarm recordings, then it is reset to 0000 and continues counting.
- When initializing the alarm recording list, the alarm recording counter will also be reset.

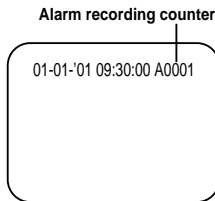

Series Recording 1

Series recording is possible if two or more of these units are connected. When the first VCR's tape reaches its end or an error occurs on VCR, the second VCR automatically begins recording.

- Press **MENU** button.
 - <MAIN MENU> appears.

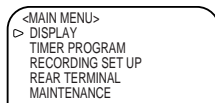

- Turn **JOG** to select **REAR TERMINAL** and turn **SHUTTLE** to the right.
 - <REAR TERMINAL> menu appears.

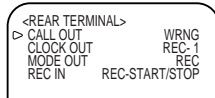

Step 3 and 4 on 1st VCR only:

- When the cursor (▷) is next to **CALL OUT**, turn **SHUTTLE** to the right.

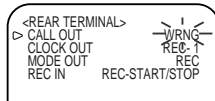

- Turn **JOG** to select **WRNG•TAPE END** and turn **SHUTTLE** to the right.

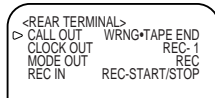

Step 5 and 6 on 2nd VCR only:

- Turn **JOG** to select **REC IN** and turn **SHUTTLE** to the right.

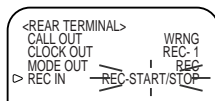

- Turn **JOG** to select **SERIES** and turn **SHUTTLE** to the right.

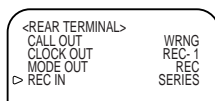

- Press **MENU** button.
 - The day and present time display appears on screen.

Series Recording 2

Series Recording 2 provides a function: when the first VCR's tape reaches its end, the second VCR automatically begins recording. When the tape in second VCR finishes, the first VCR starts recording again. (The two VCRs keep recording one after another.) Setup both 1st and 2nd VCRs as in the steps below.

- Repeat step 1 to 6 of **Series Recording 1**.
 - Steps 3 to 6 must be set to both 1st and 2nd VCRs.

- Turn **SHUTTLE** to the left.
 - <MAIN MENU> appears.

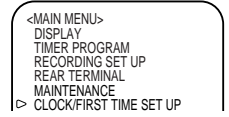

- Turn **JOG** to select **CLOCK/FIRST TIME SET UP** and turn **SHUTTLE** to the right.
 - <FIRST TIME SET UP> menu appears.

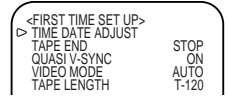

- Turn **JOG** to select **TAPE END** and turn **SHUTTLE** to the right.

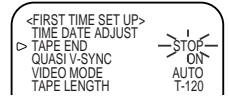

- Turn **JOG** to select **REWIND** and turn **SHUTTLE** to the right.

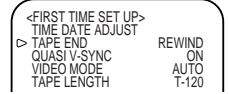

- Press **MENU** button.
 - The day and present time display appears on screen.

page 27 for series recording connection.

Note

- Timer or emergency recording function cannot be used with series recording at the same time.

Remote Recording

This function permits you to control the start/end of recording from the remote place. The VCR starts recording while the REC IN terminal is grounded.

1. Display **<REAR TERMINAL>** menu.
2. Set **REC IN** to **REC-START/STOP**.
3. Press **MENU** button.
 - The day and present time display appears on screen.

```

<REAR TERMINAL>
CALL OUT WRNG*TAPE END
CLOCK OUT REC-1
MODE OUT REC
▷ REC IN REC-START/STOP
    
```

 page 27 for remote recording connection.

Note

- An index signal will not be recorded during remote recording.
- Series or timer recording function cannot be used with remote recording at the same time.

Repeat Recording

With this function, when the tape reaches its end during recording, the VCR rewinds the tape and starts recording again.

1. Press **MENU** button.
 - **<MAIN MENU>** appears.
2. Turn **JOG** to select **CLOCK/FIRST TIME SET UP** and turn **SHUTTLE** to the right.
 - **<FIRST TIME SET UP>** menu appears.
3. Turn **JOG** to select **TAPE END** and turn **SHUTTLE** to the right.
4. Turn **JOG** to select **REPEAT** or **ALARM•PROT** and turn **SHUTTLE** to the right.
 - ⇒ Refer to the table below for REPEAT and ALARM•PROT.
 - ⇒ Repeat indicator (⌂) illuminates on the fluorescent display.
5. Press **MENU** button.
 - The day and present time display appears on screen.

```

<MAIN MENU>
▷ DISPLAY
TIMER PROGRAM
RECORDING SET UP
REAR TERMINAL
MAINTENANCE
CLOCK/FIRST TIME SET UP
    
```

```

<FIRST TIME SET UP>
TIME DATE ADJUST
▷ TAPE END STOP ON
QUASI V-SYNC AUTO
VIDEO MODE T-120
TAPE LENGTH WRNG
BUZZER
    
```

```

<FIRST TIME SET UP>
TIME DATE ADJUST
▷ TAPE END STOP ON
QUASI V-SYNC AUTO
VIDEO MODE T-120
TAPE LENGTH WRNG
BUZZER
    
```

```

<FIRST TIME SET UP>
TIME DATE ADJUST
▷ TAPE END REPEAT ON
QUASI V-SYNC AUTO
VIDEO MODE T-120
TAPE LENGTH WRNG
BUZZER
    
```

When the tape reaches its end during recording

The following functions are automatically engaged when the tape ends during recording.

TAPE END setting	When there are alarm recordings on tape	When there is NO alarm recording on tape
ALARM•PROT	The tape stops. (*)	The tape is rewound automatically to the beginning and then recording is resumed.
STOP	The tape stops.	
REWIND	The tape is rewound automatically to the beginning (except in timer recording) and then stops.	
REPEAT	The tape is rewound automatically to the beginning and then recording is resumed (also recording over existing alarms).	

- * To repeat recording on the same tape again, eject the tape once and reinsert.

One shot/Interval Recording

One shot recording allows you to control the number of fields to be recorded when the RECORD button is pressed or the REC IN terminal is grounded. Interval recording is made at the selected number of fields and at the selected interval.

1. Press **REC/PLAY MODE** button on the front panel to set the recording mode to **0H**.
2. Press **MENU** button.
 - **<MAIN MENU>** appears.
3. Turn **JOG** to select **RECORDING SET UP** and turn **SHUTTLE** to the right.
 - **<RECORDING SET UP>** menu appears.
4. Turn **JOG** to select **ONE SHOT•FIELD** and turn **SHUTTLE** to the right.
5. Turn **JOG** to select the number of recording field and turn **SHUTTLE** to the right.
6. Turn **JOG** to select **ONE SHOT•INTERVAL** and turn **SHUTTLE** to the right.

```

<MAIN MENU>
▷ DISPLAY
TIMER PROGRAM
RECORDING SET UP
REAR TERMINAL
MAINTENANCE
    
```

```

<RECORDING SET UP>
▷ ALARM REC MODE 6H
ALARM REC DURATION 1M
EMERGENCY REC OFF
SUPER RESOLUTION ON
ONE SHOT•FIELD 1
    
```

```

ALARM REC MODE 6H
ALARM REC DURATION 1M
EMERGENCY REC OFF
SUPER RESOLUTION ON
▷ ONE SHOT•FIELD 1
ONE SHOT•INTERVAL 10S
    
```

```

ALARM REC MODE 6H
ALARM REC DURATION 1M
EMERGENCY REC OFF
SUPER RESOLUTION ON
▷ ONE SHOT•FIELD 5
ONE SHOT•INTERVAL 10S
    
```

```

ALARM REC DURATION 1M
EMERGENCY REC OFF
SUPER RESOLUTION ON
ONE SHOT•FIELD 15
▷ ONE SHOT•INTERVAL 10S
    
```

For one shot recording, setup step 7 only:

7. Turn **JOG** to select **SHOT** and turn **SHUTTLE** to the right.

```

ALARM REC DURATION 1M
EMERGENCY REC OFF
SUPER RESOLUTION ON
ONE SHOT•FIELD 5
▷ ONE SHOT•INTERVAL SHOT
    
```

For interval recording, setup step 8 only:

8. Turn **JOG** to select the recording interval and turn **SHUTTLE** to the right.

```

ALARM REC DURATION 1M
EMERGENCY REC OFF
SUPER RESOLUTION ON
ONE SHOT•FIELD 5
▷ ONE SHOT•INTERVAL 30S
    
```

9. Press **RECORD** button.

- The one shot recording will be on standby mode.
- The VCR starts the interval recording with the interval time selected in step 8 above.

10. To start one shot recording, press **RECORD** button again or switch the REC IN terminal on the rear panel to the ground.

Recording Techniques (Cont.)

Note

- The recording mode must be set to L18H, L24H, L30H or L40H.
- The suitable number of VCRs and cameras to be connected are shown below:

Recording time mode	VCR	Number of cameras
L18H, L24H	3	Multiple of 3
L30H, L40H	5	Multiple of 5

Note

- If no recording is made for about 5 minutes during one shot recording standby mode, the VCR automatically records the number of fields selected in step 5.

Synchronous Recording

A number of camera images can be mixed together through a camera switcher and then recorded separately onto several VCRs. A camera is assigned to each VCR with the VCR recording only the camera image it has been assigned. This allows recording without gaps.

If you have 3 VCRs, the video signal from 3 cameras can be recorded separately by connecting the switcher as shown below:

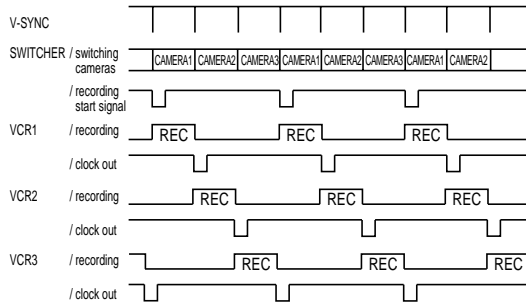

- Press **MENU** button.
 - <MAIN MENU>** appears.
- Turn **JOG** to select **REAR TERMINAL** and turn **SHUTTLE** to the right.
 - <REAR TERMINAL>** menu appears.
- Turn **JOG** to select **REC IN** and turn **SHUTTLE** to the right.

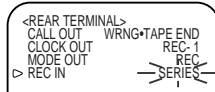
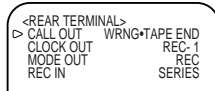
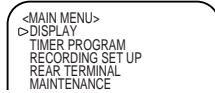

Steps 4 to 7 on VCR1 only:

- Turn **JOG** to select **SERIES** or **REC-START/STOP** and turn **SHUTTLE** to the right.
 - If the recording start signal is available on the switcher, select **SYNC REC**.
- Turn **JOG** to select **CLOCK OUT** and turn **SHUTTLE** to the right.
- Turn **JOG** to select **T/L-REC** and turn **SHUTTLE** to the right.
- Turn **JOG** to select **F** and turn **SHUTTLE** to the right.

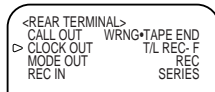
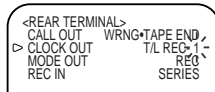
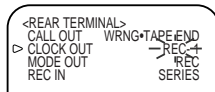
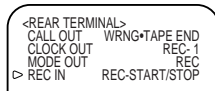

Step 8 on all VCRs except VCR1:

- Turn **JOG** to select **SYNC REC** and turn **SHUTTLE** to the right.
- Press **MENU** button.
 - The day and present time display appears on screen.

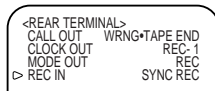

page 27 for synchronous recording connection.

Additional Features

Memory backup in case of power failure

This VCR includes a built-in backup memory, so the preset day and present time will remain in memory even if there is a power failure. However, if the power cord is disconnected for a long period of time (2-3 months), the present time may not be accurate. In this case, set the clock again.

Info.

- The battery is fully charged if the VCR's power cord is plugged into the outlet for 40 or more hours per week.
- If the battery is fully charged, even if the power cord is not plugged in, the following settings will remain in memory for up to 31 days:
 - The day and present time display
 - Timer program
 - Alarm list/Power loss list
 - Number of tape uses/Elapsed time of the VCR
 - Counter display
 - Recording/Playback mode

Note

- When ALARM REC DURATION of the RECORDING SET UP menu is set to MAN1 or MAN2 and a power failure occurs during the alarm recording, the VCR may not return to the alarm recording mode when the power comes back on.

After a power failure

If a power failure occurs during manual, timer, or alarm recording, the VCR will return to the recording mode when the power comes back on. The Power Failure symbol (X) will be displayed for about 1 minute on screen and the Power Loss indicator (PL) will illuminate on the fluorescent display when the power comes back on. If a power failure occurs while the VCR's power is on, the VCR will turn on by itself when the power comes back on.

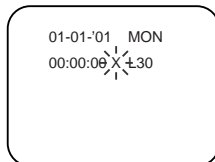

Displaying/clearing the power loss list

■ Displaying the power loss list

The power failure start time is logged in the VCR's Power Loss List. To view the list, please follow the steps listed below.

1. Press **MENU** button.
 - **<MAIN MENU>** appears.
2. Turn **JOG** to select **MAINTENANCE** and turn **SHUTTLE** to the right.
 - **<MAINTENANCE>** menu appears.
3. Turn **JOG** to select **POWER LOSS LIST** and turn **SHUTTLE** to the right.
 - **<POWER LOSS LIST>** appears.
4. Press **MENU** button.
 - The day and present time display appears on screen.

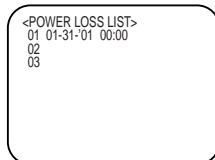
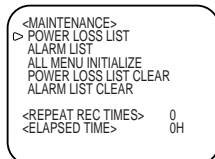

Note

- Up to 3 power failure start times will be displayed. If more than 3 failures have occurred, the first start time and the last 2 start times will be displayed on the list.

■ Clearing the power loss list

1. Select **POWER LOSS LIST CLEAR** in **<MAINTENANCE>** menu and turn **SHUTTLE** to the right.
2. Turn **SHUTTLE** to the left to clear the list.
 - **<MAINTENANCE>** menu appears.
 - ⇒ To exit the menu without clearing the list, press **MENU** button.
3. Press **MENU** button.
 - Once the list is cleared, the Power Loss indicator (PL) will go off.

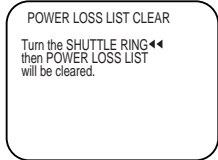

Displaying/clearing the alarm list

■ Displaying the alarm list

The alarm recording start time/date are logged in the VCR's Alarm List. To view the list, please follow the steps listed below.

1. Press **MENU** button.
 - **<MAIN MENU>** appears.
2. Turn **JOG** to select **MAINTENANCE** and turn **SHUTTLE** to the right.
 - **<MAINTENANCE>** menu appears.
3. Turn **JOG** to select **ALARM LIST** and turn **SHUTTLE** to the right.
 - **<ALARM LIST>** appears.
4. Press **MENU** button.
 - The day and present time display appears on screen.

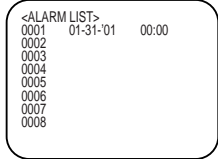
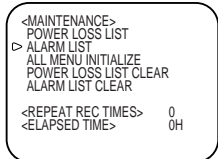

Note

- Maximum of 9,999 alarm recording start times will be counted.
- Up to 8 alarm recording start times/dates will be displayed. If more than 8 alarm recordings have occurred, the first start time and the last 7 start times will be displayed on the list.

■ Clearing the alarm list

1. Select **ALARM LIST CLEAR** in **<MAINTENANCE>** menu and turn **SHUTTLE** to the right.
2. Turn **SHUTTLE** to the left to clear the list.
 - **<MAINTENANCE>** menu appears.
 - ⇒ To exit the menu without clearing the list, press **MENU** button.
3. Press **MENU** button.
 - Once the list is cleared, the Alarm Recording indicator (ALARM) on the fluorescent display will go off.

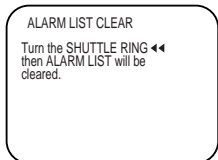

Additional Features (Cont.)

Tape usage and elapsed time of VCR

REPEAT REC TIMES indicates how many times a tape has been recorded over since it was first inserted.

ELAPSED TIME indicates the total time the VCR has been used for recording or playback.

1. Press **MENU** button.

- **<MAIN MENU>** appears.

2. Turn **JOG** to select **MAINTENANCE** and turn **SHUTTLE** to the right.

- **<REPEAT REC TIMES>** and **<ELAPSED TIME>** are shown at the bottom of the **<MAINTENANCE>** menu.

3. Press **MENU** button.

- The day and present time display appears on screen.

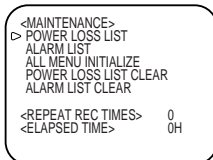

Note

- **<REPEAT REC TIMES>** is:
 - counted when the tape ends during recording (except when TAPE END of FIRST TIME SET UP menu is set to STOP)
 - memorized even if the VCR is turned off
 - reset when a tape is inserted
 - shown up to 200 times. OVER is shown if exceeds 200 times.
- **<ELAPSED TIME>** is shown up to 89,999 hours.

Lock function

Each time the **LOCK** button is pressed, the Lock/Lock All indicator illuminates on the fluorescent display in the order of LOCK → LOCK A → (No display) → LOCK → ... All or some of the buttons on the front panel of VCR are locked, and the VCR is kept in the current condition. To release the lock, press **LOCK** button until nothing is displayed on the fluorescent display.

LOCK : All buttons except RECORD button and EJECT button are locked.

LOCK A : All buttons are locked.

(No display): No buttons are locked.

Special Effects Playback

The following convenient functions are available. Audio output is muted during special effects playback.

Still picture

1. Press **PAUSE** button during playback.

- Press **PAUSE** button again to resume the playback.

Shuttle ring

By turning the SHUTTLE ring during still picture, you can obtain a variety of playback speeds as shown below.

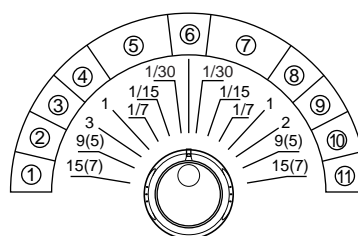

() indicates the playback speed of the recorded tape in 2H mode.

- 1 Reverse high speed search
- 2 Reverse speed search
- 3 Reverse fast playback (x3)
- 4 Reverse playback
- 5 Reverse slow
- 6 Still
- 7 Slow playback
- 8 Normal playback
- 9 Fast playback (x2)
- 10 Forward speed search
- 11 Forward high speed search

1. Turn **SHUTTLE** to the right or left during still picture.

- The playback speed varies by the angle of **SHUTTLE** ring.
- When **SHUTTLE** ring is released, it comes back to the center position and the playback picture stays at still.

Shuttle hold

When the SHUTTLE ring is released, the playback speed can be fixed to one selected.

1. Turn **SHUTTLE** to the right or left to obtain a desired playback speed, then press **PAUSE** button.

2. Release **SHUTTLE**.

■ Cancelling the shuttle hold playback

1. Press **PAUSE** button once to go back to the still picture and press once again to return to the playback.

Direct shuttle ring

By turning the SHUTTLE ring during playback, you can obtain some of special effects playback as shown below.

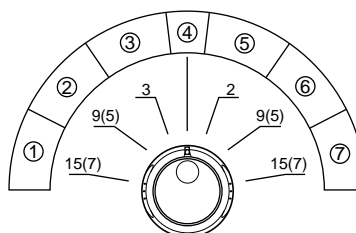

() indicates the playback speed of the recorded tape in 2H mode.

- 1 Reverse high speed search
- 2 Reverse speed search
- 3 Reverse fast playback (x3)
- 4 Normal playback
- 5 Fast playback (x2)
- 6 Forward speed search
- 7 Forward high speed search

Frame or field playback

1. To forward frames or fields one by one, turn **JOG** during still picture.
 - Turn to the right to forward.
 - Turn to the left to reverse.

To forward frames or fields continuously, keep turning **JOG** during still picture.

- Keep turning to the right to forward frames (fields) continuously.
- Keep turning to the left to reverse frames (fields) continuously.

To stop frame or field playback, release **JOG**.

- The playback picture stays at still.

Note

- Noise bars may appear on the picture while switching between forward and reverse frame or field playback.

Adjustment during Playback

Tracking adjustment

If noise appears in the picture during playback, reverse/forward slow playback, fast playback, reverse playback, frame or field playback, you can reduce or eliminate it by adjusting the tracking.

How to adjust during playback

1. Press **TRACKING** button (+) or (-) to achieve the best picture.

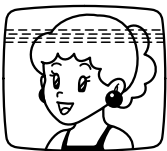

If noise appears

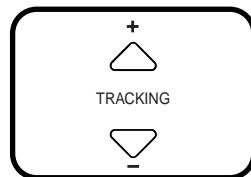

How to adjust during reverse/forward slow playback, fast playback, reverse playback, frame or field playback

1. During still picture, turn **SHUTTLE** to obtain the respective playback mode.
 - ⇒ If noise appears in frame or field playback, set to slow playback.
2. While turning **SHUTTLE**, press **PAUSE** button.
 - The playback picture is fixed at the selected speed.
3. Release **SHUTTLE**.
4. Press **TRACKING** button (+) or (-) to achieve the best picture.

Initializing the tracking

The tracking will be reset to its initial setting by pressing both **TRACKING** buttons (+) and (-) together during playback.

Note

- Adjust the tracking at each playback mode or the type of playback (fast playback, reverse playback, etc.), since the method of tracking adjustment varies.
- Although the tracking is adjusted during reverse playback or reverse slow playback, the noise may remain on screen.

- When a picture recorded in 6H or 8H mode is played back in L18H, L24H, L30H, or L40H mode, noise may appear on screen after the adjustment.
- The noise bars will move continuously when a **TRACKING** button is depressed.

Vertical adjustment (picture vibration at the top and bottom)

The picture vibration during still picture, fast playback, or playback at L18H-224H or 0H mode can be reduced or eliminated by the following steps.



When the picture is vibrating

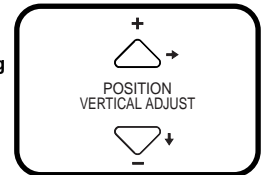

How to adjust

1. Press **PAUSE** button during playback.
2. Press **VERTICAL ADJUST** button (+) or (-) to reduce or eliminate the picture vibration.

Initializing the vertical adjustment

The vertical adjustment will be reset to its initial setting by pressing both **VERTICAL ADJUST** buttons (+) and (-) together during still picture, fast playback, or playback at L18H-224H or 0H mode.

Note

- Horizontal vibration cannot be corrected with **VERTICAL ADJUST** buttons.
- **VERTICAL ADJUST** buttons will not work, when QUASI V-SYNC of FIRST TIME SET UP menu is set to OFF.
- The picture vibration during still picture or frame or field playback may not be adjusted with **VERTICAL ADJUST** buttons.

Searching Techniques

The various search functions help you find pictures you wish to view.

Counter memory stop

Rewinds a tape until the counter on the fluorescent display reaches "00000" and stops.

1. Press **SEARCH** button once.

- **<SEARCH FUNCTION>** menu appears and **COUNTER MEMORY STOP** is highlighted.
- The Counter Memory Stop indicator (M) illuminates on the fluorescent display.

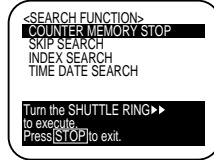

2. Turn **SHUTTLE** to the right.

- The VCR starts rewinding the tape.
- ⇒ To quit while rewinding, press **STOP** button.
- ⇒ To exit the **<SEARCH FUNCTION>** menu without rewinding, press **STOP** button.

Note

- When the counter on the fluorescent display indicates "00000," COUNTER MEMORY STOP of the SEARCH FUNCTION menu cannot be selected.

Skip search

During fast forwarding or rewinding, the VCR plays back a tape (at 2H, 6H, or 8H mode) for about 4 seconds where an index signal is recorded. This process is repeated until the end or beginning of the tape is reached.

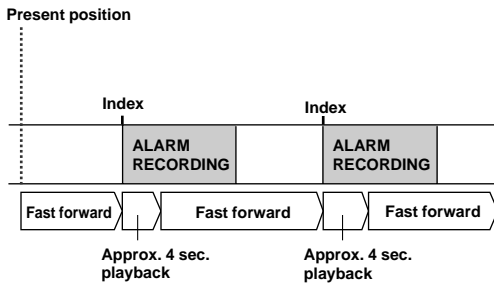

1. Press **SEARCH** button until **SKIP SEARCH** is highlighted.

- The Skip Search indicator (SKIP) illuminates on the fluorescent display.

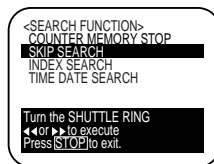

2. Turn **SHUTTLE** to the right or left.

- Turning to the right proceeds the search in the forward direction.
- Turning to the left proceeds the search in the reverse direction.
- ⇒ To quit while searching, press **STOP** button.
- ⇒ To exit the **<SEARCH FUNCTION>** menu without searching, press **STOP** button.

3. When you find a picture you wish to view, press **PLAY** button.

Note

- The index signal may be difficult to locate in some recording conditions.
- Audio output is muted during the skip search.

Info.

- Skip search or index search may not function if the interval between two alarm recording start-times is too short. The table below indicates the minimum interval between two alarm recording start-times for the skip or index search to work correctly.

Alarm recording mode	Minimum interval between two alarm recording start-times
6H(8H)	approx. 15 sec.
L18H(L24H)	approx. 2 min.
L30H(L40H)	approx. 2 min.

() appears when TAPE LENGTH is set to T-160.

Index search

During fast forwarding or rewinding, the VCR will search for an index signal you have selected. When the index signal is found, the VCR will play back in still picture.

1. Press **SEARCH** button until **INDEX SEARCH** is highlighted.

- The Index Search indicator (INDEX) illuminates on the fluorescent display.

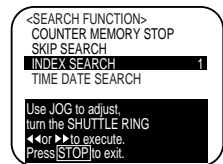

2. Turn **JOG** to select an index number (between 1 and 255) you wish to find.

- ⇒ To exit the **<SEARCH FUNCTION>** menu without searching, press **STOP** button.

3. Turn **SHUTTLE** to the right or left to start searching.

- Turning **SHUTTLE** to the right proceeds the search in the forward direction.
- Turning **SHUTTLE** to the left proceeds the search in the reverse direction.
- The index number shown on the fluorescent display will decrease one by one as each index signal goes by.
- ⇒ To quit while searching, press **STOP** button.

Note

- The index signal may be difficult to locate in some recording conditions.

Info.

How to count index number

- Index number is the count from the present position. The index number of one alarm recording before the present position is "-1." One after is "+1."
- Maximum count is ± 255 alarm recordings.

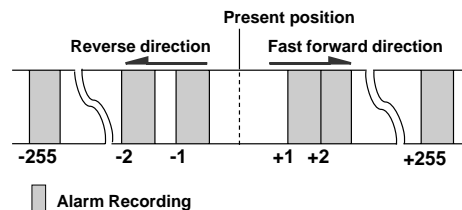

Time date search

You can easily find a picture recorded at specific date and time.

1. Press **SEARCH** button until **TIME DATE SEARCH** is highlighted.

- The Time Date Search indicator (**D**) illuminates on the fluorescent display.

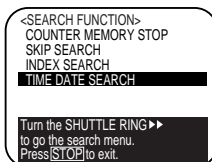

2. Turn **SHUTTLE** to the right.
 - **<TIME DATE SEARCH>** menu appears.

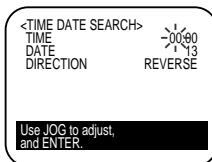

3. Turn **JOG** to set *hour digits* of **TIME** you wish to find and turn **SHUTTLE** to the right.

- ⇒ To exit the **<TIME DATE SEARCH>** menu without searching, turn **SHUTTLE** to the left several times.

4. Set *10-minute digit* and *1-minute digit* of **TIME**, **DATE**, and **DIRECTION** in a similar fashion.

- Searches in the forward direction of the tape when **DIRECTION** is set to **FORWARD**.
- Searches in the reverse direction of the tape when **DIRECTION** is set to **REVERSE**.

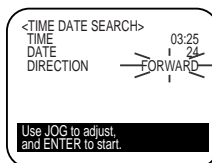

5. Turn **SHUTTLE** to the right to start searching.

- When the recorded picture is found, it is shown at still picture.

- ⇒ To quit while searching, press **STOP** button.

Note

- An index mark is written on a tape at each hour (1:00, 2:00, and so on) during recording. The time date search cannot be resumed if the index mark of the hour (set in step 3) is not recorded on a tape.

Example: When the VCR recorded from 8:15 to 17:30 on a tape, only pictures recorded between 9:00 and 17:30 can be found using the time date search.

- The time date search may not function correctly, if you use a tape with a poor recording quality or with alarm recordings recorded at several recording mode.
- The time date search will not function when using a tape recorded with other VCRs or a tape recorded without setting the current day and time.

Info.

- When the desired part of the tape is not found in the selected direction, the VCR automatically searches in the opposite direction.

Using with Personal Computer

Configuring the time lapse VCR

Important notice:

- Before connecting the hardware, unplug the power cord of the VCR from the wall outlet, and turn the personal computer power off.

■ Connecting the VCR to a personal computer

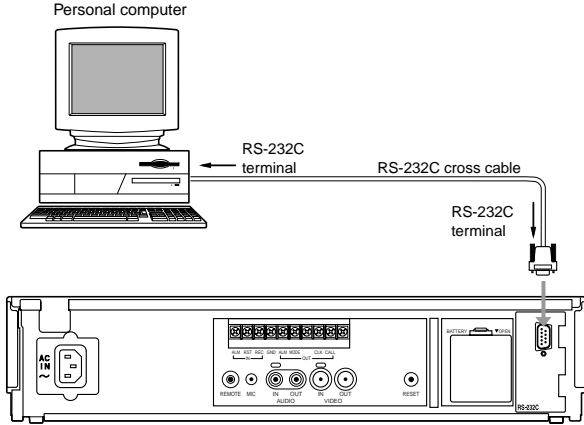

1. Connect the RS-232C cross cable to the RS-232C terminal of the personal computer.
2. Connect the other end of cable to RS-232C terminal on the VCR.

RS-232C setting

Set the RS-232C interface board setting by using the on screen menu of the VCR.

1. Press **MENU** button.

- **<MAIN MENU>** appears.

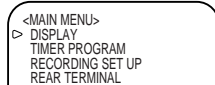

2. Turn **JOG** to select **CLOCK/FIRST TIME SET UP** and turn **SHUTTLE** to the right.

- **<FIRST TIME SET UP>** menu appears.

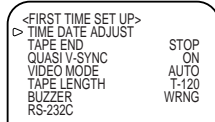

3. Turn **JOG** to select **RS-232C** and turn **SHUTTLE** to the right.

- **<RS-232C>** menu appears.

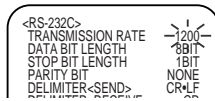

4. Change the parameter value by turning **JOG** to the left or right and turn **SHUTTLE** to the right to store the new value.

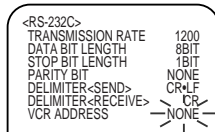

5. Repeat step 4 until all of the items are set.

- **<FIRST TIME SET UP>** menu appears after setting VCR ADDRESS.

6. Press **MENU** button.

- The day and present time display appears on screen.

Note

- Set all parameters to the same values as the controlling personal computer or other equipment.
- The PARITY BIT cannot be used when the DATA BIT LENGTH is set to 8BIT.

- When controlling only one VCR via the personal computer, VCR ADDRESS is set to NONE.
- When VCRs have a unique VCR ADDRESS (from VCR01 to VCR255), VCRs can be controlled remotely via a personal computer.

Connecting to a Personal Computer

A personal computer that has an RS-232C serial port can be used to remotely control the VCR.

■ Physical protocol of RS-232C

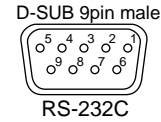

No.	Signal line names	Meanings	Directions (from VCR side)
2	RD	Receive data	INPUT
3	SD	Transmit data	OUTPUT
4	ER	Data terminal ready	OUTPUT
5	SG	Signal ground	-
6	DR	Data set ready	INPUT
7	RS	Request send	OUTPUT
8	CS	Clear to send	INPUT

■ Data communication settings

Synchronization	Asynchronous
Transmission rate	1200/2400/4800/9600 bps
Data bit length	1bit/2bit
Stop bit length	7bit/8bit
Parity bit	Nil/Even/Odd
Xcontrol	Nil
S parameter	Nil
CS-RS hand-shake	With
Delimiter code for send	CR(0DH)/CR(0DH)+LF(0AH)
Delimiter code for receive	CR(0DH)/CR(0DH)+LF(0AH)

■ Cable connections

Before connecting the hardware, unplug the power cord of the VCR from the outlet, and turn the personal computer power off. Connect the RS-232C terminal of the VCR to the personal computer's serial port.

1. When the RS-232C connector of the computer is D-SUB 25pin.

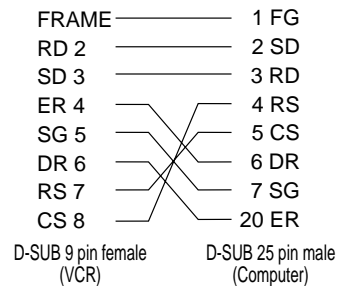

2. When the RS-232C connector of the computer is D-SUB 9pin.

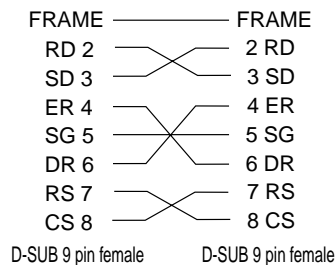

Commands from personal computer

The commands sent from the personal computer (or other equipment) to the VCR and responses produced by the VCR are detailed in this section.

- **When controlling only one VCR via the personal computer, the VCR ADDRESS of RS-232C menu is set to NONE.**

Command : Commands set to the VCR.



Status : Response codes from the VCR.

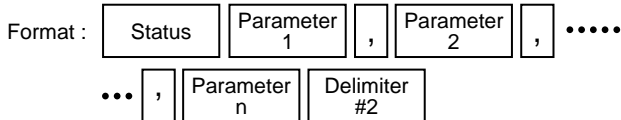

Note

- #1 When you set DELIMITER<RECEIVE> to CR, input the carriage return code (0DH).
When you set DELIMITER<RECEIVE> to CR•LF, input the carriage return code (0DH) and line feed code (0AH).
- #2 When you set DELIMITER<SEND> to CR, the carriage return code (0DH) will be inputted.
When you set DELIMITER<SEND> to CR•LF, the carriage return code (0DH) and line feed code (0AH) will be inputted.

Example 1:

Switch on the VCR. (When DELIMITER<SEND> and DELIMITER<RECEIVE> of RS-232C menu are set to CR.)

Sending commands from the PC, etc.	Status or error code from the VCR to PC, etc.	Meanings
PW1 <input type="checkbox"/> CR	RC <input type="checkbox"/> CR EX <input type="checkbox"/> CR	Power ON command Command received Command carried out

* CR indicates carriage return code (0DH).

Example 2:

Recording was attempted, but failed because the erase prevention tab of the tape was broken. (When DELIMITER<SEND> and DELIMITER<RECEIVE> of RS-232C menu are set to CR.)

Sending commands from the PC, etc.	Status or error code from the VCR to PC, etc.	Meanings
RC <input type="checkbox"/> CR	RC <input type="checkbox"/> CR ER02 <input type="checkbox"/> CR	Command for recording Command received Failed because the erase prevention tab of the tape is broken.

* CR indicates carriage return code (0DH).

- **When controlling two or more VCRs from a personal computer, the VCR ADDRESS of each VCR is set to the different address (from VCR01 to VCR255, except NONE).**

- Input the "VCR ADDRESS (e.g., VCR01)" that you want to control and ", (comma)" before inputting the command code.
- When you want to control all connected VCRs, input "ALL" and ", (comma)" before inputting the command codes.

Command : Commands set to the VCR.

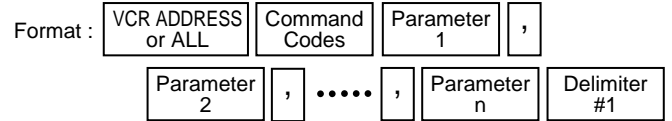

Status : Response codes from the VCR to outside.

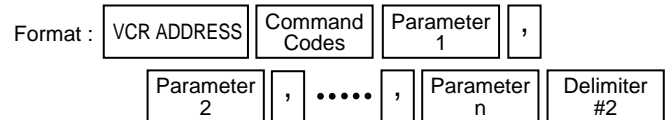

Note

- #1 When you set DELIMITER<RECEIVE> to CR, input the carriage return code (0DH).
When you set DELIMITER<RECEIVE> to CR•LF, input the carriage return code (0DH) and line feed code (0AH).
- #2 When you set DELIMITER<SEND> to CR, the carriage return code (0DH) will be inputted.
When you set DELIMITER<SEND> to CR•LF, the carriage return code (0DH) and line feed code (0AH) will be inputted.

Example 1:

Fast forward the tape in the VCR of the ID number VCR02. (When the DELIMITER<SEND> and DELIMITER<RECEIVE> of RS-232C menu are set to CR.)

Sending commands from the PC, etc.	Status or error code from the VCR to PC, etc.	Meanings
VCR02, FF <input type="checkbox"/> CR	VCR02, RC <input type="checkbox"/> CR VCR02, EX <input type="checkbox"/> CR	Command for fast forwarding (VCR02) Command received (VCR02) Command carried out (VCR02)

* CR indicates carriage return code (0DH).

Example 2:

Set the clock of the all VCR connected to 12:27. (When DELIMITER<SEND> and DELIMITER<RECEIVE> of RS-232C menu are set to CR.)

Sending commands from the PC, etc.	Status or error code from the VCR to PC, etc.	Meanings
ALL, SC12,27 <input type="checkbox"/> CR	VCR01, RC <input type="checkbox"/> CR VCR01, EX <input type="checkbox"/> CR ⋮ VCR255, RC <input type="checkbox"/> CR VCR255, EX <input type="checkbox"/> CR	Command for setting all VCRs' clocks at 12:27 Command received (VCR01) Command carried out (VCR01) ⋮ Command received (VCR255) Command carried out (VCR255)

* CR indicates carriage return code (0DH).

- * The order and number of the status responses from the VCRs to the PC or other controller may vary dependent upon the number of VCRs and the ID number settings.

Using with Personal Computer (Cont.)

Commands and Responses

- **#1** : Input the code according to DELIMITER<RECEIVE> setting {CR (0DH) or CR (0DH) + LF (0AH)}.
- **#2** : The code according to DELIMITER<SEND> setting {CR (0DH) or CR (0DH) + LF (0AH)} will be inputted.
- * indicates one character or number. (e.g., *** indicates three characters or numbers.)

NO.	Commands	Functions	Status after normal execution	Explanation of status
1	PW#1	Power ON/OFF	RC#2EX #2	Command received and carried out
2	PW0#1	Power OFF	↑	↑
3	PW1#1	Power ON	↑	↑
4	EJ#1	Eject	↑	↑
5	SP#1	Stop	↑	↑
6	PB#1	Playback	↑	↑
7	RP#1	Reverse playback	↑	↑
8	FF#1	Fast forward	↑	↑
9	RW#1	Rewind	↑	↑
10	RC#1	Recording	↑	↑
11	CM#1	Counter memory stop	↑	↑
12	PU#1	Pause ON/OFF	↑	↑
13	PU0#1	Pause OFF	↑	↑
14	PU1#1	Pause ON	↑	↑
15	FA#1	Frame advance (when still)	↑	↑
16	RA#1	Reverse frame advance (when still)	↑	↑
17	LK#1	Lock OFF	↑	↑
18	LK0#1	Lock ON	↑	↑
19	LK1#1	Lock All ON	↑	↑
20	SF#1	Skip search (forward)	↑	↑
21	SR#1	Skip search (reverse)	↑	↑
22	IF***#1	Index search (forward) (***=001-255)	↑	↑
23	IR***#1	Index search (reverse) (***=001-255)	↑	↑
24	IN#1	Enquiry about current index No. (during index search)	RC#2ID***#2	Index No. is ***=001-255
25	TR#1	Timer recording ON/OFF	RC#2EX #2	Command received and carried out
26	TRO#1	Timer recording OFF	↑	↑
27	TR1#1	Timer recording ON	↑	↑
28	TP#1	Enquiry about current executing timer program No.	RC#2TN*#2	Timer program No. is *=1-8 (Note)ER08,when not timer recording
29	SS#1	Enquiry about current VCR status	RC#2ST00#2 RC#2ST01#2 RC#2ST02#2 RC#2ST03#2 RC#2ST04#2 RC#2ST05#2 RC#2ST06#2 RC#2ST07#2 RC#2ST08#2 RC#2ST09#2 RC#2ST10#2 RC#2ST11#2 RC#2ST12#2 RC#2ST13#2 RC#2ST14#2 RC#2ST15#2 RC#2ST16#2 RC#2ST17#2 RC#2ST18#2 RC#2ST19#2 RC#2ST20#2 RC#2ST21#2 RC#2ST22#2 RC#2ST23#2 RC#2ST24#2 RC#2ST25#2 RC#2ST26#2 RC#2ST27#2 RC#2ST29#2 RC#2ST30#2 RC#2ST31#2 RC#2ST32#2 RC#2ST33#2 RC#2ST34#2	Power off, cassette in Power off, cassette out Power on, cassette in Power on, cassette out Fast forward underway Rewind underway Recording underway Recording pause underway Playback underway Reverse playback underway Forward speed search underway Reverse speed search underway Still underway Counter memory stop underway Skip search (fast forward) underway Skip search (rewind) underway Playback during skip search Index search (fast forward) underway Index search (rewind) underway Rewind during repeat recording Alarm recording underway Timer recording underway Standby for timer recording Timer recording error underway Time date search standby underway Time date FF search underway Time date REW search underway Time date search or point adjustment underway Recording check underway Alarm recording Index writing underway Time date index writing underway Oneshot recording underway Frame advance underway Reverse frame advance underway
30	LO*#1	Lock ON/OFF or Lock All ON/OFF *:0=OFF, 1=ON	RC#2EX #2	Command received and carried out
31	LM#1	Enquiry about current lock status and lock mode	RC#2LM*#2	*: 0=Lock off, 1=Lock on 2=Lock All on
32	CR#1	Counter reset	RC#2EX #2	Command received and carried out
33	CT#1	Enquiry about current counter display value	RC#2CT *****#2	*****=00000-99999

NO.	Commands	Functions	Status after normal execution	Explanation of status
34	MC *** ^[#1]	Switch over REC/PLAY mode to <for 96-hour model> ***= 006, L18, L30, 048, 072, 096, 000 <for 168-hour model> ***= 006, L18, L30, 048, 072, 096, 120, 168, 000	RC ^[#2] EX ^[#2]	Command received and carried out
35	MD ^[#1]	Enquiry about current REC/PLAY mode	RC ^[#2] MD*** ⁽¹⁾ ^[#2]	*** ⁽¹⁾ : (same as item 34)
36	DP ^[#1]	Change menu to the next layer	RC ^[#2] EX ^[#2]	Command received and carried out
37	DP*** ^[#1]	Switch screen page to ***: 000=present time display 100=MAIN MENU 110=DISPLAY menu 120=SEARCH FUNCTION menu 121=TIME DATE SEARCH menu 130=TIMER PROGRAM menu 131=PROGRAM TO RECORD menu 132=HOLIDAY SET UP menu 140=RECORDING SET UP menu 150=REAR TERMINAL menu 160=MAINTENANCE menu 161=POWER LOSS LIST 162=ALARM LIST 163=ALL MENU INITIALIZE 164=POWER LOSS LIST CLEAR 165=ALARM LIST CLEAR 170=FIRST TIME SET UP menu 171=TIME DATE ADJUST menu 172=RS-232C menu	↑	↑
38	PI ^[#1]	Enquiry about current screen page	RC ^[#2] ON*** ⁽¹⁾ * ⁽²⁾ ^[#2]	*** ⁽¹⁾ : (same as item 37), 050=LANGUAGE SELECT * ⁽²⁾ : 0=Setting completed, 1=Setting underway
39	SD** ⁽¹⁾ , ** ⁽²⁾ , ** ⁽³⁾ ^[#1]	Current date setting ** ⁽¹⁾ :Month, ** ⁽²⁾ :Day, ** ⁽³⁾ :Year	RC ^[#2] EX ^[#2]	Command received and carried out
40	DT ^[#1]	Enquiry about current date	RC ^[#2] TD** ⁽¹⁾ , ** ⁽²⁾ , ** ⁽³⁾ , * ⁽⁴⁾ ^[#2]	** ⁽¹⁾ , - ** ⁽³⁾ : (same as item 39) * ⁽⁴⁾ : Day of the week 0=SUN, 1=MON, 2=TUE, 3=WED, 4=THU, 5=FRI, 6=SAT
41	SC** ⁽¹⁾ , ** ⁽²⁾ ^[#1]	Current time setting ** ⁽¹⁾ :Hour, ** ⁽²⁾ :Minute	RC ^[#2] EX ^[#2]	Command received and carried out
42	TM ^[#1]	Enquiry about current time	RC ^[#2] TI** ⁽¹⁾ , ** ⁽²⁾ , ** ⁽³⁾ ^[#2]	** ⁽¹⁾ :Hour, ** ⁽²⁾ :Minute, ** ⁽³⁾ :Second
43	TD ^[#1]	Enquiry about power failure symbol	RC ^[#2] MK* ^[#2]	*: 0=Not Displayed, 1=Displayed
44	PS** ⁽¹⁾ , ** ⁽²⁾ ^[#1]	Time and date display position ** ⁽¹⁾ :Horizontal =01-30 (mode 1, size large) =01-52 (mode 1, size small) =01-39 (mode 2,3 size large) =01-62 (mode 2,3 size small) ** ⁽²⁾ :Vertical =01-37 (mode 1, size large or small) =01-35 (mode 2,3 size large or small)	RC ^[#2] EX ^[#2]	Command received and carried out
45	LC ^[#1]	Enquiry about time and date display position	RC ^[#2] LT** ⁽¹⁾ , ** ⁽²⁾ ^[#2]	** ⁽¹⁾ , ** ⁽²⁾ : (same as item 44)
46	PG* ⁽¹⁾ , * ⁽²⁾ , ** ⁽³⁾ , ** ⁽⁴⁾ , ** ⁽⁵⁾ , ** ⁽⁶⁾ , ** ⁽⁷⁾ , * ⁽⁸⁾ ^[#1]	Timer program setting * ⁽¹⁾ :Program No.=1-8 * ⁽²⁾ :Day of the week (0=SUN, 1=MON, 2=TUE, 3=WED, 4=THU, 5=FRI, 6=SAT, 7=DAY, 8=SPL, 9=HLD) ** ⁽³⁾ :Rec. starting hour=00-23 ** ⁽⁴⁾ :Rec. starting minute=00-59 ** ⁽⁵⁾ :Rec. ending hour=00-23 ** ⁽⁶⁾ :Rec. ending minute=00-59 ** ⁽⁷⁾ :Rec. time mode= (same as item 34), SKP * ⁽⁸⁾ :REC mode 1=EP, 3=EP/EXT (EXT= external timer recording)	RC ^[#2] EX ^[#2]	Command received and carried out (Note) An error (ER08) will occur if an attempt is made to program a timer program number that has already been set. Clear the timer program contents with the "CA*" command and then retry.
47	PM* ^[#1]	Enquiry about setting contents of timer program No. (*=1-8)	RC ^[#2] MP* ⁽¹⁾ , * ⁽²⁾ , ** ⁽³⁾ , ** ⁽⁴⁾ , ** ⁽⁵⁾ , ** ⁽⁶⁾ , ** ⁽⁷⁾ , * ⁽⁸⁾ ^[#2]	* ⁽¹⁾ , - * ⁽⁸⁾ (=same as item 46)
48	CA* ^[#1]	Clear contents of timer program No. (*=1-8)	RC ^[#2] EX ^[#2]	Command received and carried out
49	DW* ⁽¹⁾ , * ⁽²⁾ ^[#1]	Setting the special day of the week * ⁽¹⁾ :Start day of the week (0-6) * ⁽²⁾ :End day of the week (0-6) 0=SUN, 1=MON, 2=TUE, 3=WED, 4=THU, 5=FRI, 6=SAT	↑ (Cannot accept this command when * ⁽¹⁾ and * ⁽²⁾ are the same number)	↑

Using with Personal Computer (Cont.)

NO.	Commands	Functions	Status after normal execution	Explanation of status
50	DW?#1	Enquiry about setting of the special day of the week	RC#2 DW* ⁽¹⁾ , * ⁽²⁾ #2	* ⁽¹⁾ :Start day (of the week) (0-6) * ⁽²⁾ :End day (of the week) (0-6) 0=SUN, 1=MON, 2=TUE, 3=WED, 4=THU, 5=FRI, 6=SAT
51	AM**#1	Alarm recording mode setting **=06, 18, 30	RC#2 EX#2	Command received and carried out
52	AS1#1	Enquire of alarm recording mode setting	RC#2 AM**#2	**=06, 18, 30
53	AD*#1	Alarm REC duration setting *:0=MAN1, 1=MAN2, 2=15S, 3=30S, 4=45S, 5=1M, 6=2M, 7=5M, 8=10M	RC#2 EX#2	Command received and carried out
54	ASO#1	Enquiry about alarm REC duration setting	RC#2 AP*#2	*:(same as item 53)
55	EM#1	Emergency REC ON/OFF	RC#2 EX#2	Command received and carried out
56	EMO#1	Emergency REC OFF	↑	↑
57	EM1#1	Emergency REC ON	↑	↑
58	AS2#1	Enquiry about emergency REC setting	RC#2 EG*#2	*:0=OFF, 1=ON
59	TE *#1	Tape end movement setting *: 0=STOP, 1=REWIND, 2=REPEAT, 3=ALARM•PROT (protect)	RC#2 EX#2	Command received and carried out
60	FSO#1	Enquiry about tape end movement set	RC#2 TE*#2	*:(same as item 59)
61	DM*#1	Display mode setting *=1-4	RC#2 EX#2	Command received and carried out
62	DM?#1	Enquiry about display mode setting	RC#2 DM*#2	*=1-4
63	CHO#1	Set date character display size "SMALL"	RC#2 EX#2	Command received and carried out
64	CH1#1	Set date character display size "LARGE"	↑	Command received and carried out
65	FS1#1	Enquiry about date character display size	RC#2 CZ*#2	*: 0=SMALL, 1=LARGE
66	CO* ⁽¹⁾ , ** ⁽²⁾ #1	Clock out setting * ⁽¹⁾ :0=REC, 1=T/L REC ** ⁽²⁾ :01, 02, 03, 04, 05, 10, 15, 20, 25, 30, 50, 60, 00(output by field)	RC#2 EX#2	Command received and carried out
67	RO#1	Enquiry about clock out setting	RC#2 CD* ⁽¹⁾ , ** ⁽²⁾ #2	* ⁽¹⁾ * ⁽²⁾ :(same as item 66)
68	MO*#1	Mode out setting *: 0=REC, 1=PLAY, 2=POWER, 3=TAPE IN, 4=TAPE REMAIN, 5=CLOCK ADJ	RC#2 EX#2	Command received and carried out
69	RM#1	Enquiry about MODE OUT setting	RC#2 MR*#2	*:(same as item 68)
70	CU*#1	CALL OUT setting *:0=OFF, 1=ON Receive the command only when the signal at the CALL OUT terminal is switched to the active condition.	RC#2 EX#2	Command received and carried out
71	CU?#1	Enquiry about CALL OUT setting	RC#2 CU*#2	*: 0=OFF, 1=ON
72	BL*#1	Blue Back setting *: 0=OFF, 1=ON	RC#2 EX#2	Command received and carried out
73	BL?#1	Enquiry about Blue Back setting	RC#2 BL*#2	*: 0=OFF, 1=ON
74	ST*#1	Set menu item to flash *:0=OFF, 1=ON	RC#2 EX#2	Command received and carried out
75	BZ*#1	Buzzer setting *: 0=WRNG, 1=WRNG•TAPE END, 2=WRNG•REMAIN, 3=OFF	RC#2 EX#2	Command received and carried out
76	BR*#1	Buzzer ON/OFF setting *:0=OFF, 1=ON	↑	↑
77	FS2#1	Enquiry about buzzer setting	RC#2 BZ*#2	*:(same as item 75)
78	BP#1	Enquiry about buzzer status	RC#2 SW*#2	*: 0=OFF (not ring), 1=ON (ring)
79	OS**#1	One shot field setting **: 01, 02, 03, 04, 05, 10, 20, 30	RC#2 EX#2	Command received and carried out
80	OF#1	Enquiry about one shot field setting	RC#2 SD**#2	**:(same as item 79)
81	OI*#1	Oneshot interval setting *: 0=SHOT, 1=10S, 2=15S, 3=30S 4=45S, 5=1M, 6=2M, 7=3M	RC#2 EX#2	Command received and carried out
82	OI?#1	Enquiry about one shot interval setting	RC#2 OI*#2	*:(same as item 81)
83	AN#1	Enquiry about current alarm REC. No.	RC#2 AN*****#2	*****=0000-9999
84	AT*#1	Enquiry about alarm list *: 0=about the first alarm recording 1-7=about the last to seventh last alarm recording	RC#2 AT** ⁽¹⁾ , ** ⁽²⁾ , ** ⁽³⁾ , ** ⁽⁴⁾ , ** ⁽⁵⁾ #2	** ⁽¹⁾ :Month, ** ⁽²⁾ :Day, ** ⁽³⁾ :Year, ** ⁽⁴⁾ :Hour, ** ⁽⁵⁾ :Minute
85	CA#1	Clearing alarm list	RC#2 EX#2	Command received and carried out
86	PN#1	Enquiry about current power loss No.	RC#2 PN**#2	**=00-99
87	PT*#1	Enquiry about power loss list *: 0=about the first power loss 1=about the second last power loss 2=about the last power loss	RC#2 PT** ⁽¹⁾ , ** ⁽²⁾ , ** ⁽³⁾ , ** ⁽⁴⁾ , ** ⁽⁵⁾ #2	** ⁽¹⁾ :Month, ** ⁽²⁾ :Day, ** ⁽³⁾ :Year, ** ⁽⁴⁾ :Hour, ** ⁽⁵⁾ :Minute
88	PC#1	Clearing power loss list	RC#2 EX#2	Command received and carried out
89	MI#1	Initializing the menu setting	↑	↑
90	HM?#1	Enquiry about the elapsed time	RC#2 HM*****#2	*****=hour
91	WN#1	Enquiry about warning information	RC#2 WN**#2	**=Warning No. 00=no malfunction, 01=tape end 03=video input missing 04=clogged head, 05=reel rotation trouble 06=loading motor trouble 07=capstan motor trouble 08=drum motor trouble 09=tape loose, 10=switching power short, 11=cut tape

NO.	Commands	Functions	Status after normal execution	Explanation of status
92	CA0 ^{#1}	Clearing the warning "ER05"	RC ^{#2} EX ^{#2}	Command received and carried out
93	RI ^{#1}	REC IN setting *: 0=SERIES, 1=REC-START/STOP 2=SYNC REC	↑	↑
94	RI? ^{#1}	Enquiry about REC IN setting	RC ^{#2} RI ^{#2}	*:(same as item 93)
95	QV ^{#1}	QUASI-VSYNC setting * :0=OFF, 1=ON	RC ^{#2} EX ^{#2}	Command received and carried out
96	QM ^{#1}	Enquiry about QUASI-VSYNC setting	RC ^{#2} QV ^{#2}	*: 0=OFF, 1=ON
97	CL ^{#1}	CALL OUT setting *: 0=WRNG, 1=WRNG•TAPE END 2=WRNG•REMAIN	RC ^{#2} EX ^{#2}	Command received and carried out
98	RL ^{#1}	Enquiry about CALL OUT setting	RC ^{#2} CL ^{#2}	*:(same as item 97)
99	SM ^{#1}	DAYLIGHT SAVING setting *: 0=OFF, 1=ON, 2=AUTO	RC ^{#2} EX ^{#2}	Command received and carried out
100	SM? ^{#1}	Enquiry about DAYLIGHT SAVINGS setting	RC ^{#2} SM ^{#2}	*: 0=OFF, 1=ON, 2=AUTO OFF, 3=AUTO ON
101	RS? ^{#1}	Enquiry about REPEAT REC TIMES	RC ^{#2} RS ^{#2} RC ^{#2} RSOVER ^{#2}	*** : 000-200 OVER (more than 201 times)
102	TL ^{#1}	Tape length setting *: 0=T-120, 1=T-160	RC ^{#2} EX ^{#2}	Command received and carried out
103	TL? ^{#1}	Enquiry about tape length setting	RC ^{#2} TL ^{#2}	*:(same as item 102)
104	LP? ^{#1}	Enquiry about tape remaining time	RC ^{#2} LP ^{#2}	* ⁽¹⁾ :Hour,* ⁽²⁾ :Minute
105	TF ^{#1} , ^{#2} , ^{#3}	Time date search (forward) setting ** ⁽¹⁾ :Day,* ⁽²⁾ :Hour,* ⁽³⁾ :Minute	RC ^{#2} EX ^{#2}	Command received and carried out
106	TB ^{#1} , ^{#2} , ^{#3}	Time date search (reverse) setting ** ⁽¹⁾ :Day,* ⁽²⁾ :Hour,* ⁽³⁾ :Minute	↑	↑
107	TS? ^{#1}	Enquiry about time date search setting	RC ^{#2} TS ^{#2}	** ⁽¹⁾ :Day,* ⁽²⁾ :Hour,* ⁽³⁾ :Minute
108	MQ ^{#1}	VIDEO MODE setting * : 1=B/W, 2=AUTO	RC ^{#2} EX ^{#2}	Command received and carried out
109	SB1 ^{#1}	Enquiry about VIDEO MODE	RC ^{#2} SQ ^{#2}	* : (same as item 108)
110	MM ^{#1}	Menu language selection * : 0=English, 1=French, 2=Spanish	RC ^{#2} EX ^{#2}	Command received and carried out
111	SB3 ^{#1}	Enquiry about selected menu language	RC ^{#2} SP ^{#2}	* : (same as item 110) 8=Language is not selected
112	RN? ^{#1}	Enquiry about recording/playback mode, SP/EP	RC ^{#2} RN ^{#2}	* : 0=SP, 1=EP
113	SV? ^{#1}	Enquiry about recording format	RC ^{#2} SV ^{#2}	* : 0=VHS, 2=Super Resolution
114	HL ^{#1} , ^{#2} , ^{#3}	Holiday set up setting ** ⁽¹⁾ :Position No. 01-20,* ⁽²⁾ :Month, ** ⁽³⁾ :Day	RC ^{#2} EX ^{#2}	Command received and carried out
115	EH ^{#1}	Clearing holiday set up setting ** : Position No. 01-20	↑	↑
116	HC ^{#1}	Enquiry about holiday set up setting on line 1 to 5 * : Line No. 1-5	RC ^{#2} HC ^{#2} , ^{#3} , ^{#4} , ^{#5} , ^{#6} , ^{#7} , ^{#8} , ^{#9} , ^{#10} , ^{#11} , ^{#12} , ^{#13} , ^{#14} , ^{#15} , ^{#16} , ^{#17} , ^{#18} , ^{#19} , ^{#20}	** ⁽¹⁾ :Month,* ⁽²⁾ :Day
117	CG ^{#1}	<for168-hour model only> Clog detection ON/OFF *:0=OFF, 1=ON	RC ^{#2} EX ^{#2}	Command received and carried out
118	CG? ^{#1}	<for168-hour model only> Enquiry about clog detection setting	RC ^{#2} CG ^{#2}	* : 0=OFF, 1=ON
119	HR ^{#1}	Super Resolution ON/OFF	RC ^{#2} EX ^{#2}	Command received and carried out
120	HR0 ^{#1}	Super Resolution OFF	↑	↑
121	HR1 ^{#1}	Super Resolution ON	↑	↑
122	HR? ^{#1}	Enquiry about Super Resolution setting	RC ^{#2} HR ^{#2}	* : 0=OFF, 1=ON

Error code

NO.	Errors	Meaning of error
1	ER00	No power supply
2	ER01	No cassette loaded
3	ER02	Broken tape tab (unable to record)
4	ER03	Beginning of the tape
5	ER04	Tape end
6	ER05	Problem with the tape, video input or VCR mechanism
7	ER06	Present time or timer program not yet set

NO.	Errors	Meaning of error
8	ER07	Alarm REC underway (Unable to change setting)
9	ER08	Unfeasible
10	ER10	Incorrect command
11	ER11	Incorrect parameter
12	ER12	Overflow of the VCR's command receive buffer
13	ER13	Data not received correctly

Connections for Various Functions

Connecting with CCTV camera, monitor, and sensor

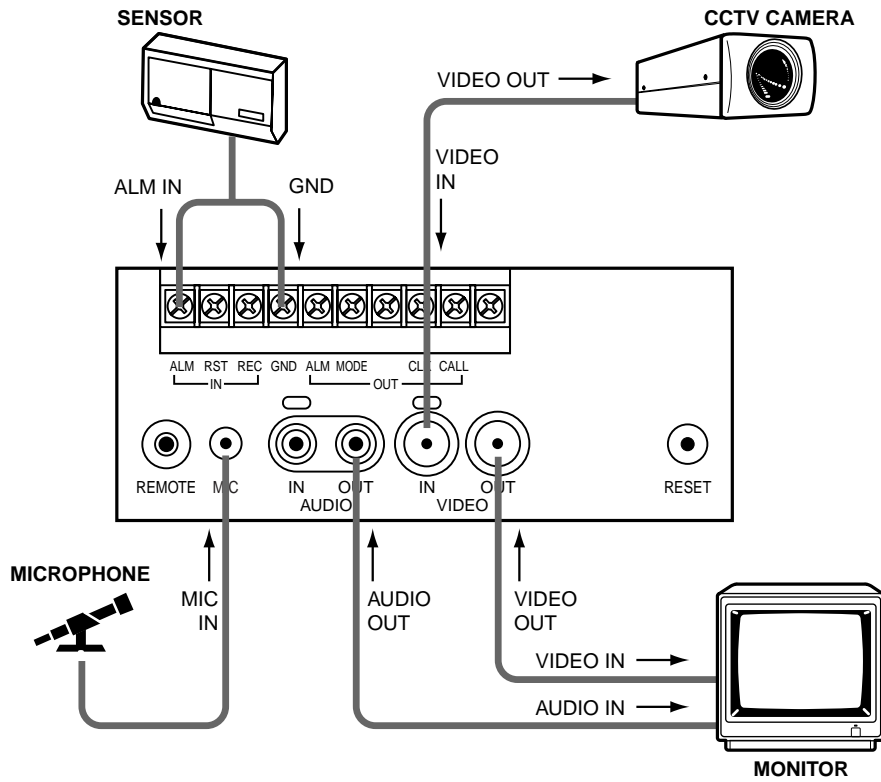

Note

- Monitor to be connected
 - Connecting with a CCTV monitor (for surveillance) is recommended.
 - Connecting with some monitors may cause picture vibration and/or picture distortion at the top or bottom of the image at still picture or normal playback.
 - A television for domestic use may easily cause the picture vibration and distortion.
 - A monitor can also be connected to the VIDEO OUT connector on the front panel.
- CCTV camera to be connected
 - Do not connect 'Color' and 'Black & White' cameras together.

Alarm Recording Connection

The alarm can be confirmed from a distance by connecting the ALM OUT terminal with an existing alarm system panel or other peripherals such as a buzzer. Connect the VCR and other peripherals as shown below. (☞ page 11 for the menu setting and page 37 for the rating of each terminal.)

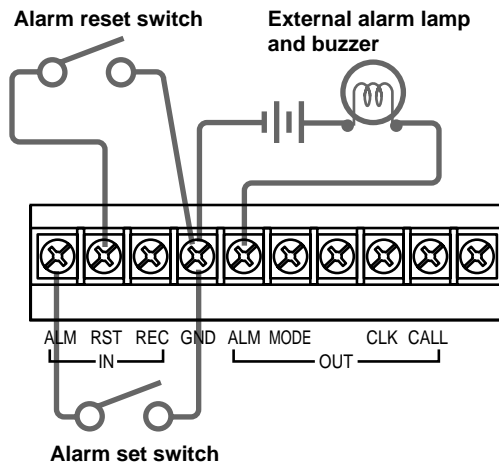

Series Recording Connection

Connect VCRs to be used as shown below. (☞ page 12 for the menu setting.)

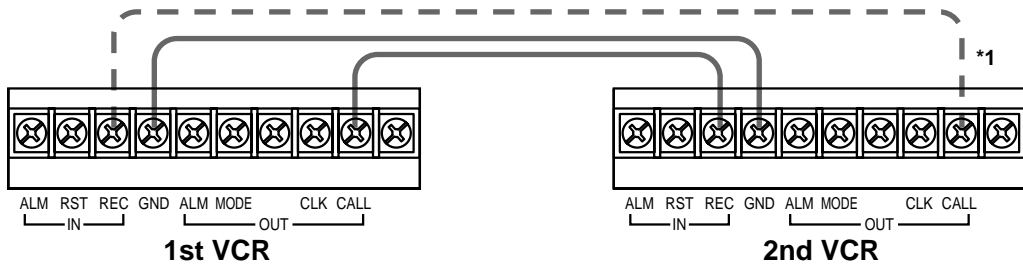

*1 : This connection is necessary in case of **Series Recording 2**.

Remote Recording Connection

Connect the VCR with a remote switch as to the right. (☞ page 13 for the menu setting and page 37 for the rating of each terminal.)

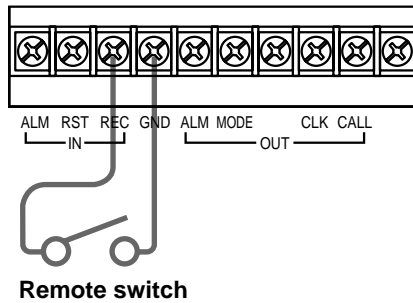

Synchronous Recording Connection

Connect VCRs as shown below. (☞ page 14 for the menu setting.)

Note The number of VCRs to be connected varies by the recording time mode selected.

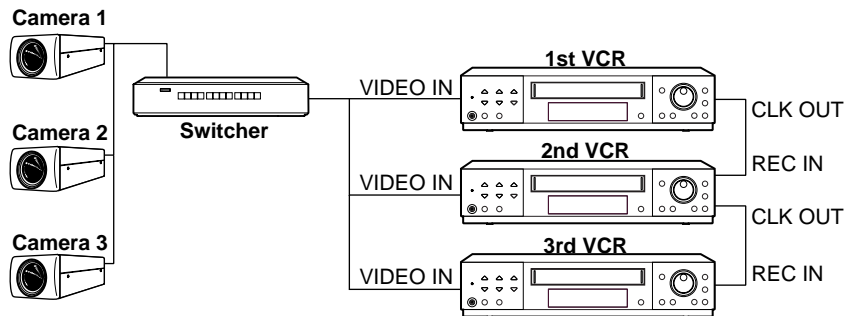

Connection for External Time Clock Adjustment

Connect VCRs as shown below. (☞ next page for the menu setting and page 37 for the rating of each terminal.)

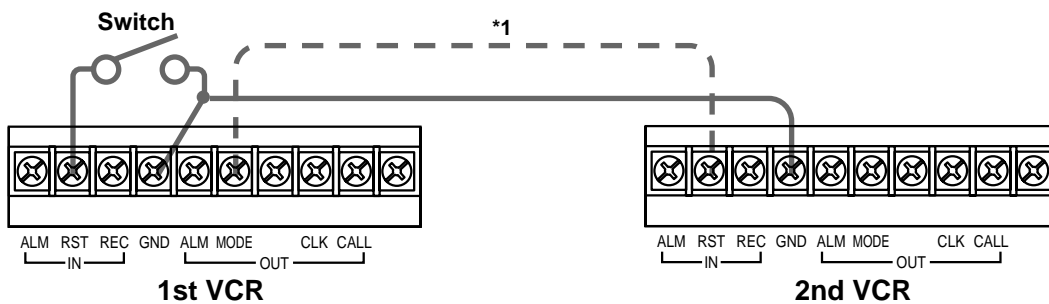

*1 : When connecting the MODE OUT terminal of the first VCR with the RST IN terminal of the second VCR, the on-screen clock of the second VCR can be adjusted to that of the first VCR.

Setting the Clock

Accurately set the day and present time before timer programming.

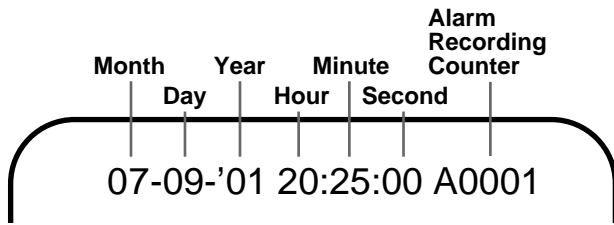

- '01 indicates year 2001.
- The clock is shown in 24-hour format.
- Alarm recording counter is shown during alarm recording only.

Example : Setting the day and present time to 8:25 p.m., 9 July 2002.

1. Press **MENU** button.
 - <MAIN MENU> appears.

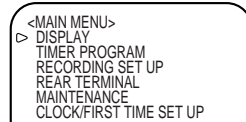

2. Turn **JOG** to select **CLOCK/FIRST TIME SET UP** and turn **SHUTTLE** to the right.
 - <FIRST TIME SET UP> menu appears.

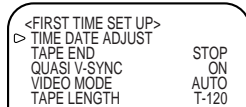

3. Turn **JOG** to select **TIME DATE ADJUST** and turn **SHUTTLE** to the right.
 - <TIME DATE ADJUST> menu appears.



4. Turn **JOG** to set **DAYLIGHT SAVINGS** and turn **SHUTTLE** to the right.
 - When set to **ON**, the clock moves forward one hour.
 - When set to **AUTO**, the clock moves forward one hour from the 1st Sunday of April (at 2 a.m.) to the last Sunday of October (at 3 a.m.).
 - When set to **ON** or **AUTO** and the clock is put forward one hour, the Daylight Saving Time symbol (⌘) is shown next to the hour digit of **TIME** on screen and the Daylight Saving Time indicator (■) illuminates on the fluorescent display.



Note

- When the DAYLIGHT SAVINGS is set to AUTO, the programmed recordings starting or finishing in the daylight saving time changeover period may not be recorded correctly.
 - The daylight saving time may vary from the one above depending on your region or the year, in this case, set DAYLIGHT SAVINGS to ON or OFF manually.
5. Turn **JOG** to show "07" for **MONTH** and turn **SHUTTLE** to the right.
 6. Set **DAY**, **YEAR**, **TIME** (hour digits, 10-minute digit and 1-minute digit) in a similar fashion.

7. Turn **SHUTTLE** to the right while the 1-minute digit of **TIME** is flashing.
 - The setting is now complete.
 - <FIRST TIME SET UP> menu appears.

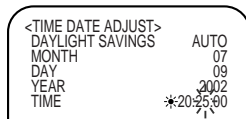

8. Press **MENU** button.
 - The day and present time display appears on screen.

Info.

- When **DAYLIGHT SAVINGS** is set to **ON** or **OFF** and a tape is not inserted in the VCR, **DAYLIGHT SAVINGS** can be switched to **ON** or **OFF** on the front panel of the VCR by pressing **STOP** button and **EJECT** button together.
- To move the displayed position of the day and present time on screen, press **POSITION** button (→) or (↓). (→) moves the display in a right-forward direction and (↓) in a downward direction.

Setting the current time to exact second

Set the clock as described above, but set minute digits to one or two minutes ahead of the reference time being used. When the reference time reaches 00 seconds of the minute you have set, turn **SHUTTLE** to the right. The VCR's clock now corresponds to the reference time to the nearest second.

External time clock adjustment

The VCR's clock can be set to the nearest hour by connecting with an external clock. When 2 or more VCRs are connected together, the clock can be set to the 1st VCR's clock simultaneously. Make the following settings to all VCRs you wish to set the clock. (Refer previous page for the connection.)

1. Press **MENU** button.
 - <MAIN MENU> appears.
2. Set **ALARM REC DURATION** of <RECORDING SET UP> menu to other than **MAN1**.

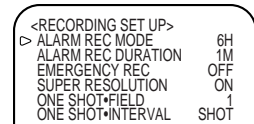

3. Set **MODE OUT** of <REAR TERMINAL> menu to **CLOCK ADJ.**

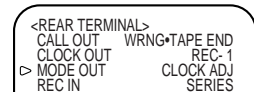

4. Press **MENU** button.
 - The day and present time display appears on screen.

How the external time clock adjustment works

When the RST IN terminal is grounded at the rear panel, the clock is automatically set to the nearest hour.

Example:

- When the display shows 11:29:59, the clock is adjusted to 11:00:00.
- When the display shows 11:30:00, the clock is adjusted to 12:00:00.

When more than 2 VCRs are connected and the clock of the 1st VCR is adjusted to the nearest hour, the additional VCRs will also be set to the nearest hour.

Note A point to notice

Info. Supplementary information

Setting the Menus

Menu Chart

CLOG DETECT of <RECORDING SET UP> menu is available for 168-hour model only.

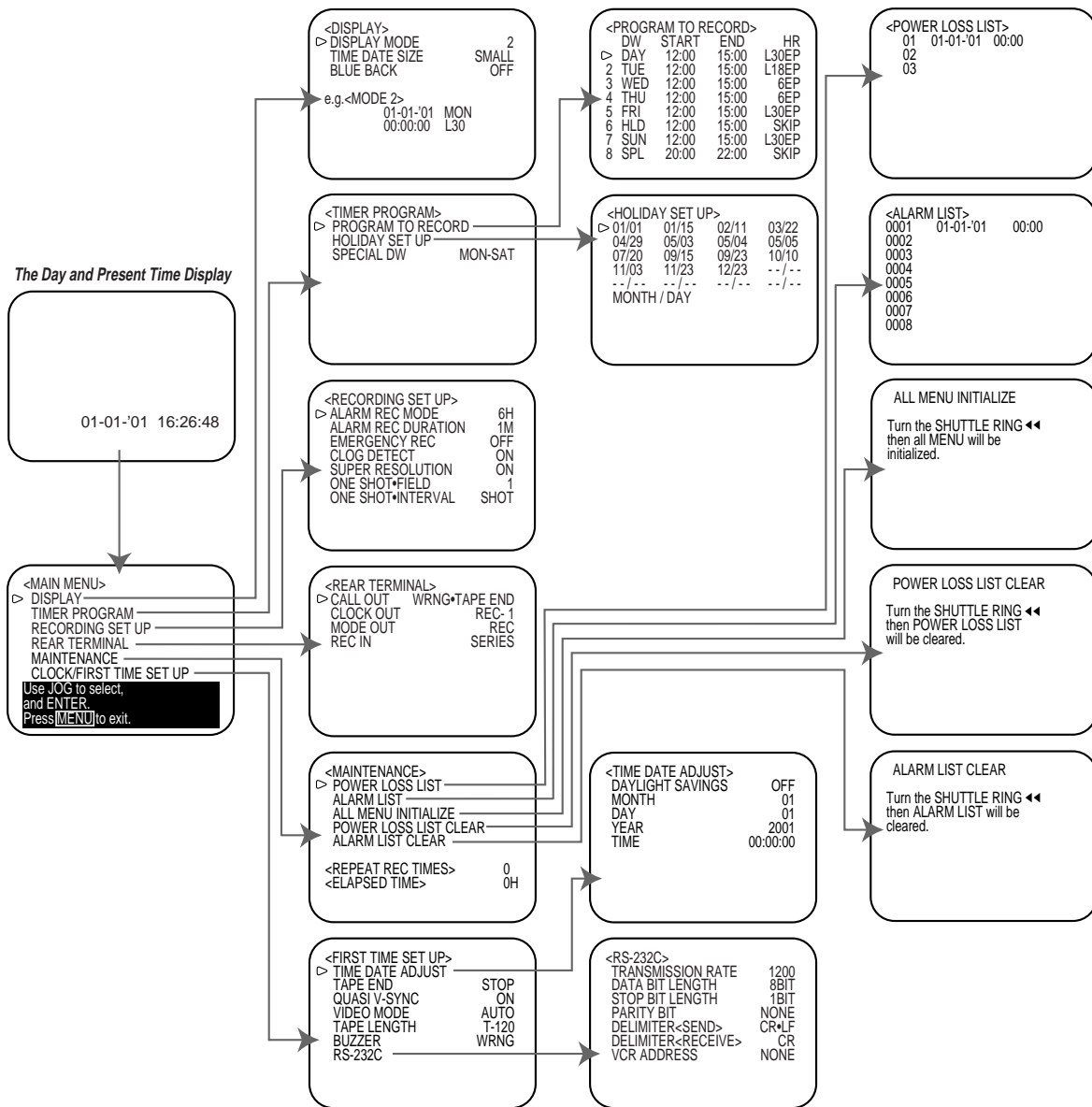

Set the menus by the following steps.

1. Press **MENU** button.
 - <MAIN MENU> appears.
2. Turn **JOG** to the left or right to select the desired item.
 - When turned to the right, the cursor moves downward.
 - When turned to the left, the cursor moves upward.
3. Turn **SHUTTLE** to the right.
 - The desired item is selected and the menu appears.
4. Turn **JOG** to the left or right to select item.
5. Turn **SHUTTLE** to the right, then the setting item flashes.
6. Turn **JOG** to the left or right to change the setting.
7. Turn **SHUTTLE** to the right to set.
8. Press **MENU** button.
 - The day and present time display appears.

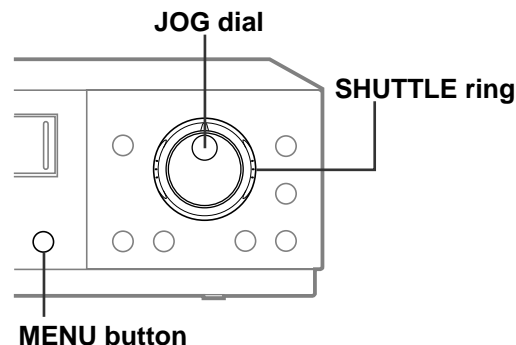

Setting the Menu (Cont.)

LANGUAGE SELECTION

The menu which appears on screen offers 3 languages, English (ENGLISH), Spanish (ESPAÑOL) or French (FRANÇAIS).

This menu appears by pressing MENU button, when the VCR is turned on for the first time after the purchase or when RESET button is pressed during use.

- Press **MENU** button.
 - The menu as shown to the right appears.
- Turn **JOG** to select the desired language.
- Turn **SHUTTLE** to the right.
 - <MAIN MENU>** in the selected language appears on screen.
- Press **MENU** button to exit.

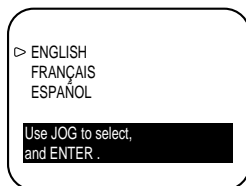

Note

- After first time setup and selection of the language to be used, the only way to go back and access the main menu in the three languages is to PRESS the **RESET** button found on the rear panel. The **RESET** button can be accessed with a small pointed object. Once the **RESET** button is pressed, repeat steps 1 to 4 above.

MAIN MENU

DISPLAY

Sets the display format of the date and present time on screen.

TIMER PROGRAM

Sets the timer recording.

RECORDING SET UP

Sets the alarm recording mode, alarm recording duration, emergency recording, etc.

REAR TERMINAL

Sets the frequency division ratio of CLOCK OUT, output signal of CALL OUT terminal, MODE OUT terminal, etc.

MAINTENANCE

Displays the power loss list, alarm list, etc. Also, initializes all menu settings and clears the power loss list and alarm list.

CLOCK/FIRST TIME SET UP

Sets the present time and the operation at the tape end, etc.

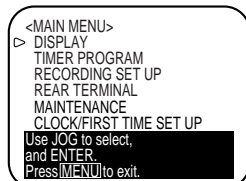

DISPLAY

Setting the display mode (DISPLAY MODE)

- Shows date and present time.
- Shows date, day of the week, present time and recording mode.
- Displays nothing. In case of alarm recording, displays same items as DISPLAY MODE 2.
- Displays nothing.

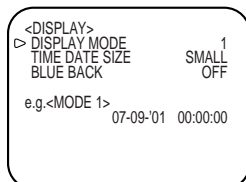

DISPLAY MODE 1

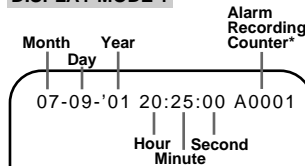

DISPLAY MODE 2 and 3

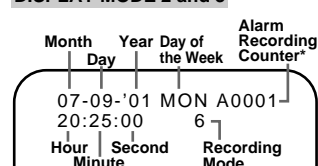

* shown when DISPLAY MODE 1, 2, or 3 is selected.

Setting the size of letter for date and present time display (TIME DATE SIZE)

SMALL : The size of the letters become small.

LARGE : The size of the letters become large.

Setting the background color (BLUE BACK)

ON : The blue colored screen overlays on the recorded picture when the menu is displayed on the monitor.

OFF : The recorded picture is overlaid with the menu display.

Note

- When the setting is OFF and the video signal is not input, the blue colored screen overlays on the recorded picture when the menu is displayed on the monitor.
- When the setting is ON and the video signal is not input, the background color will be in blue. Also, the warning "NO SIGNAL" flashes on screen and "noSIG" flashes on the fluorescent display during recording.

TIMER PROGRAM

☞ page 10, **Timer Recording.**

RECORDING SET UP

Setting the alarm recording mode (ALARM REC MODE)

Sets the alarm recording time mode.

- Providing TAPE LENGTH in FIRST TIME SET UP menu is set to T-120.

When JOG is turned, the display will be switched in the order of 6H → L18H → L30H → 6H → ...

- Providing TAPE LENGTH in FIRST TIME SET UP menu is set to T-160.

When JOG is turned, the display will be switched in the order of 8H → L24H → L40H → 8H → ...

Setting the alarm recording duration (ALARM REC DURATION)

Sets the duration of the alarm recording period. When JOG is turned, the display will be switched in the order of 1M (minute) → 2M → 5M → 10M → MAN1 → MAN2 → 15S (second) → 30S → 45S → 1M → ...

Setting the emergency recording (EMERGENCY REC)

ON : Starts alarm recording when the ALM IN terminal is grounded while the VCR is recording, in stop mode, turned off, or in stand-by mode for timer recording.

OFF : Starts alarm recording when the ALM IN terminal is grounded during recording.

Setting the clog detection (CLOG DETECT) (For 168-hour model only)

ON : The VCR automatically removes any particles that may accumulate on the heads during the recording at 120H-224H or 0H (except for 128H mode). If it cannot be entirely removed, a warning "CLog" flashes on the fluorescent display (☞ page 36).

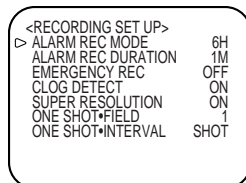

OFF : The VCR does not detect clogged head.

Setting the super resolution (SUPER RESOLUTION)

ON : Recording/playback is made at over 400 lines of resolution.

OFF : Recording/playback is made at VHS mode.

Setting the number of fields in oneshot recording (ONE SHOT•FIELD)

Sets the number of recorded fields in the oneshot recording mode. When JOG is turned, the display will be switched in the order of 1 → 2 → 3 → 4 → 5 → 10 → 20 → 30 → 1 → ...

Setting the interval time in the oneshot recording (ONE SHOT•INTERVAL)

Sets the interval time in the oneshot recording mode. When JOG is turned, the display will be switched in the order of SHOT → 10S (second) → 15S → 30S → 45S → 1M (minute) → 2M → 3M → SHOT → ...

REAR TERMINAL

Setting the operation mode of the CALL OUT terminal (CALL OUT)

Sets the mode of call signal output from the CALL OUT terminal. If any abnormalities occur with the VCR during recording, the call signal is output from the CALL OUT terminal on the rear panel regardless of CALL OUT setting.

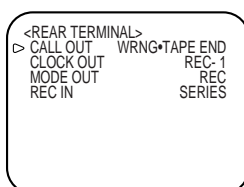

WRNG•TAPE END : The VCR outputs a call signal when the tape reaches its end during recording or when a malfunction occurs during recording. The VCR's function when the tape ends depends on the setting of TAPE END in FIRST TIME SET UP menu (☞ next column).

WRNG•REMAIN : The VCR outputs a call signal when a malfunction occurs during recording or when the tape has approximately 9 minutes (at 6H mode) left during recording.

WRNG : The VCR outputs a call signal only when a malfunction occurs during recording.

Setting the recording mode and frequency division ratio (CLOCK OUT)

Sets the recording mode and the frequency division ratio of clock pulse output from the CLOCK OUT terminal.

- Setting the recording mode during the clock pulse output

REC : When recording in any mode.

T/L REC : When recording in time-lapse mode (L18H-224H or 0H).

- Setting the frequency division ratio of the clock pulse output.

When JOG is turned, the display will be switched in the order of 1 → 2 → 3 → 4 → 5 → 10 → 15 → 20 → 25 → 30 → 50 → 60 → F (field) → 1 → ...

The numbers 1 to 60 indicate the number of frames at 6H recording mode and the number of fields at time lapse recording modes. (One frame consists of two fields.) When set to F (field), one field is selected.

Setting the operation mode of the MODE OUT terminal (MODE OUT)

A mode signal is output under the following circumstances.

REC : During recording.

PLAY : During playback.

POWER : While the VCR is turned on.

TAPE IN : When a tape is inserted in the VCR.

TAPE REMAIN : When the tape has approximately 9 minutes (at 6H mode) left.

CLOCK ADJ : When the clock indicates "00(min.):00(s)". (The signal is output for 1 second only.)

Setting the operation mode of REC IN terminal (REC IN)

SERIES : Recording starts when the REC IN terminal is grounded.

REC-START/STOP : Recording continues while the REC IN terminal is grounded. If the signal is input for a short period, the VCR may not start recording.

SYNC REC : The video signal from the multiple of 3 or 5 cameras can be recorded separately by connecting a switcher (☞ page 14 for the menu setting and page 27 for the connection).

MAINTENANCE

Displaying the power loss list (POWER LOSS LIST)

☞ page 15.

Displaying the alarm list (ALARM LIST)

☞ page 15.

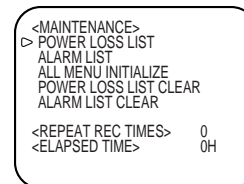

Initializing all menu settings (ALL MENU INITIALIZE)

All menus will be initialized except timer programs.

1. Press **MENU** button.

- **<MAIN MENU>** appears.

2. Turn **JOG** to select **MAINTENANCE** and turn **SHUTTLE** to the right.

- **<MAINTENANCE>** menu appears.

3. Turn **JOG** to select **ALL MENU INITIALIZE** and turn **SHUTTLE** to the right.

- **<ALL MENU INITIALIZE>** menu appears.

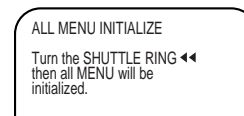

4. Turn **SHUTTLE** to the left.

- The setting of all menus (except TIMER PROGRAM) will return to its initial setting.

☞ To exit the menu without initializing all menus, press **MENU** button.

5. Press **MENU** button.

- The day and present time display appears on screen.

Clearing the power loss list (POWER LOSS LIST CLEAR)

☞ page 15.

Clearing the alarm list (ALARM LIST CLEAR)

☞ page 15.

Displaying number of tape use (REPEAT REC TIMES)

☞ page 16.

Displaying the elapsed time of VCR (ELAPSED TIME)

☞ page 16.

Setting the Menus (Cont.)

FIRST TIME SET UP

Setting the present time, date and Daylight Saving Time settings (TIME DATE ADJUST)

☞ page 28.

Setting operation of VCR when the tape reaches its end during recording or playback (TAPE END)

The VCR's function when the tape reaches its end during recording is as follows.

STOP : The tape stops, the indication "End" appears on the fluorescent display and "TAPE END" on screen. When CALL OUT is set to WRNG•TAPE END, a call signal is output from the CALL OUT terminal.

REWIND : Rewinds the tape to the beginning and stops (except during timer recording). When CALL OUT is set to WRNG•TAPE END and a tape reaches its end, a call signal is output for 2 seconds from the CALL OUT terminal.

REPEAT : Rewinds the tape to the beginning and resumes the recording. When CALL OUT is set to WRNG•TAPE END and a tape reaches its end, a call signal is output for 2 seconds from the CALL OUT terminal.

ALARM•PROT (alarm protection) :

If any alarm recordings are present on the tape and the tape stops, the indication "End" appears on the fluorescent display and "TAPE END" on screen. When CALL OUT is set to WRNG•TAPE END, a call signal is output from the CALL OUT terminal. If there is no alarm recording, the VCR rewinds the tape to the beginning and resumes the recording.

☞ Go to page 8 for the VCR's function when the tape reaches its end during playback.

Setting Quasi-V-sync on or off (QUASI V-SYNC)

ON : Quasi-V-sync. signal is inserted to the video output signal in the special effects playback (☞ page 16) or normal playback in L18H-128H (for 96-hour model), L18H-224H (for 168-hour model) or 0H mode.

OFF : Quasi-V-sync. signal is not inserted.

Note

- Some multiplexers may require QUASI V-SYNC to be OFF in order to work properly.

Setting the playback/recording color mode (VIDEO MODE)

AUTO : The VCR automatically switches the circuits according to type of the input/playback video signal, color or black & white.

B/W : Select for recording or playback in black & white.

Setting the tape length (TAPE LENGTH)

T-120 : Select when using a T-120 tape.

T-160 : Select when using a T-160 tape.

Setting to sound buzzer during warning (BUZZER)

WRNG : The buzzer sounds when there is any malfunction in the VCR.

WRNG•TAPE END : The buzzer sounds when there is any malfunction in the VCR or the tape reaches its end.

```
<FIRST TIME SET UP>
▷ TIME DATE ADJUST
  TAPE END          STOP
  QUASI V-SYNC     ON
  VIDEO MODE       AUTO
  TAPE LENGTH      T-120
  BUZZER           WRNG
  RS-232C
```

WRNG•REMAIN : The buzzer sounds when there is any malfunction in the VCR or the tape has approximately 9 minutes (at 6H mode) left.

OFF : The buzzer does not sound.

Note

- To stop the buzzer:

Press **MENU** button once. If <MAIN MENU> appears, press **MENU** button again to exit the menu. When the VCR is locked, press **LOCK** button to unlock the VCR, then the buzzer stops.

Setting the RS-232C parameters

See the next section.

RS-232C

Setting the transmission rate (TRANSMISSION RATE)

When JOG is turned, the display will be switched in the order of 1200 (bps) → 2400 → 4800 → 9600 → 1200 → ...

```
<RS-232C>
▷ TRANSMISSION RATE 1200
  DATA BIT LENGTH  8BIT
  STOP BIT LENGTH   1BIT
  PARITY BIT        NONE
  DELIMITER<SEND>  CR•LF
  DELIMITER<RECEIVE> CR
  VCR ADDRESS      NONE
```

Setting the data bit length (DATA BIT LENGTH)

When JOG is turned, the display will be switched in the order of 8BIT → 7BIT → 8BIT → ...

Setting the stop bit length (STOP BIT LENGTH)

When JOG is turned, the display will be switched in the order of 1BIT → 2BIT → 1BIT → ...

Setting the parity bit (PARITY BIT)

When JOG is turned, the display will be switched in the order of NONE → ODD → EVEN → NONE → ...

Setting a character marking the end of a status or error code (DELIMITER<SEND>)

When JOG is turned, the display will be switched in the order of CR•LF → CR → CR•LF → ...

Setting a character marking the end of a command (DELIMITER<RECEIVE>)

When JOG is turned, the display will be switched in the order of CR•LF → CR → CR•LF → ...

Setting the ID number of the VCR (VCR ADDRESS)

When JOG is turned, the display will be switched in the order of NONE → VCR01 → VCR02 → → VCR254 → VCR255.

Remote Controller (Optional)

The optional remote controller (R-9100) provides remote operation of the VCR. Connect to the REMOTE terminal at the VCR's rear panel before use.

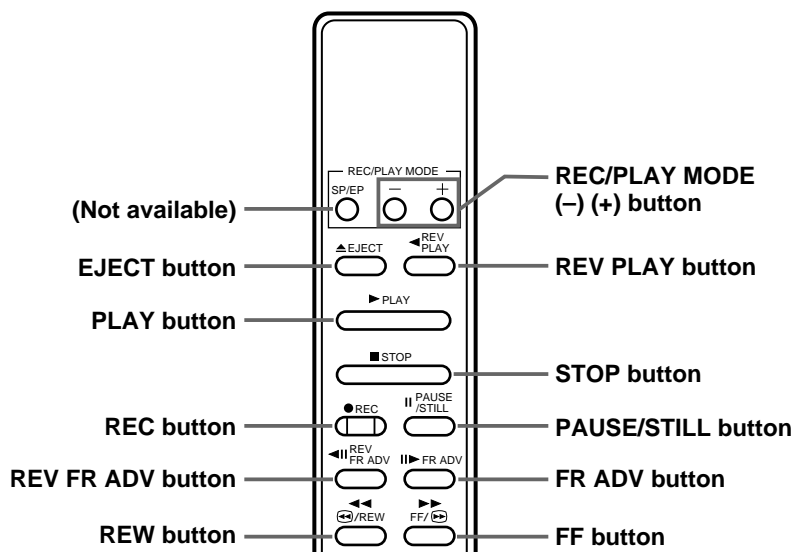

Remote Jack

Circuit

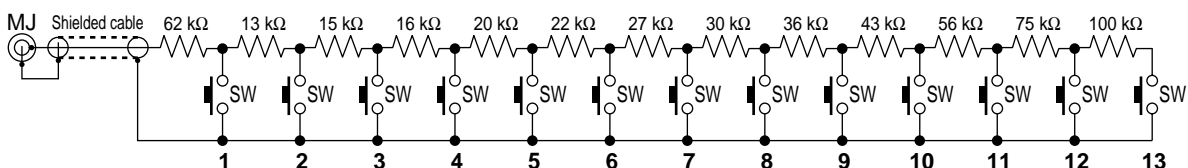

- 1) Resistor : Metal film resistor 1/4 W, resistance tolerance $\pm 1\%$
Temperature factor ± 100 PPM/ $^{\circ}$ C
- 2) Button switch : Momentary, ON resistor 200 Ω or under
- 3) Connector MJ : Miniature jack, 2.5 mm in diameter, comply with JISC6560

Operational conditions

- 1) Isolation resistor : 200 M Ω or over (in connector MJ)
- 2) Floating capacity : 0.1 μ F or under (in connector MJ)
- 3) Environmental temperature : 5-40 $^{\circ}$ C (common with VCR)
- 4) Relative temperature : Max. 80 % (common with VCR)

Remote control switch functions

Position	Function	Position	Function
1	EJECT	9	FORWARD FRAME SHIFT
2	STOP	10	REVERSE FRAME SHIFT
3	RECORDING	11	(+) REC/PLAY MODE
4	PAUSE	12	(-) REC/PLAY MODE
5	PLAYBACK	13	(Not available)
6	REVERSE PLAYBACK		
7	FAST FORWARD		
8	REWIND		

Before Calling for Service

When you find any problem with this VCR, first check the following. If you still cannot solve the problem, stop using the VCR, unplug it from an outlet and contact your dealer.

Symptom	Remedy
---------	--------

Installation

No power supplied to VCR.	<ul style="list-style-type: none"> • Has the power cord been disconnected from the outlet? • Is the Lock or Lock All indicator (LOCK/LOCK A) illuminated? → Press LOCK button on the front panel several times to unlock the VCR. • Is the Timer Recording indicator (⏏) illuminated? → Press TIMER RECORD button on the front panel to cancel the timer recording.
The VCR POWER is ON but the VCR does not operate.	<ul style="list-style-type: none"> • Is the Lock or Lock All indicator (LOCK/LOCK A) illuminated? → Press LOCK button on the front panel several times to unlock the VCR. • Safety devices are in operation. → Press RESET button on the rear panel using a pointed instrument. And then turn the power on again.
No picture is obtained on the MONITOR screen.	<ul style="list-style-type: none"> • Is the monitor or the camera connected correctly? → Check the connection. • Is the connecting cable properly connected, or is the cable defective? → Check the connection and also check the snapping of a wire in the cable.
The picture is not clear on the monitor.	<ul style="list-style-type: none"> • Is the camera focused? → See the user's manual for your camera and focus the camera correctly.

Function/operation

No operation when any tape operation button is pressed.	<ul style="list-style-type: none"> • Is the Lock or Lock All indicator (LOCK/LOCK A) illuminated? → Press LOCK button on the front panel several times to unlock the VCR. • Is a cassette inserted?
The present time is not correct even if using the VCR everyday.	→ Make sure the power cord is connected to the outlet for approximately 40 or more hours per week when using it everyday.
The power cord has been disconnected for less than 31 days but the present time has been reset.	→ Make sure the power cord is connected to the outlet for approximately 40 or more hours per week when using it everyday. <ul style="list-style-type: none"> • The reserved contents may be erased even within 31 days depending on the charging time of the power failure compensation circuit. → Set the present time setting again.
A tape cannot be loaded.	<ul style="list-style-type: none"> • Is the Lock All indicator (LOCK A) illuminated? → Press LOCK button on the front panel once to unlock the VCR.

Recording

Recording does not work by pressing the RECORD button.	<ul style="list-style-type: none"> • Is the Lock All indicator (LOCK A) illuminated? → Press LOCK button on the front panel once to unlock the VCR. • Has the cassette's erasure prevention tab been broken off? → Load the cassette with its erasure prevention tab intact. • Has the tape run out? → Rewind the tape or load a new tape.
Recording cannot be stopped by pressing the STOP button.	<ul style="list-style-type: none"> • Is the Lock or Lock All indicator (LOCK/LOCK A) illuminated? → Press LOCK button on the front panel several times to unlock the VCR. • Is the VCR in timer recording mode (Timer recording indicator (⏏) is illuminating)? → Press TIMER RECORD button once.
Repeat recording does not work.	<ul style="list-style-type: none"> • Is the Repeat indicator (↺) illuminated? → Set TAPE END in the FIRST TIME SET UP menu to REPEAT or ALARM•PROT. When TAPE END in the FIRST TIME SET UP menu is set to ALARM•PROT, repeat recording does not work using a tape with an alarm recording. When a tape reaches its end during the emergency recording (recording started while the VCR is stopped or the VCR power is off), the VCR rewinds the tape and stops (recording does not start again) even though TAPE END in the FIRST TIME SET UP menu is set to REPEAT.

Symptom	Remedy
---------	--------

Recording (continued)

Timer recording does not operate.	<ul style="list-style-type: none"> • Have the day and present time been set accurately? → Set the day and present time again. • Have the recording start-time, recording end-time, and the recording mode been set accurately? → Confirm the settings on the <PROGRAM TO RECORD>. • Is the Timer Recording indicator (⏻) illuminated? → If not, press TIMER RECORD button on the front panel to standby the timer recording.
Alarm recording does not work.	<ul style="list-style-type: none"> • Is the external switch connected correctly? → Check the connection. • Is the Emergency Recording indicator (EMGCY) illuminated? → Set EMERGENCY REC in the RECORDING SET UP menu to ON.

Playback

No operation when the PLAY button is pressed.	<ul style="list-style-type: none"> • Is the Lock or Lock All indicator (LOCK/LOCK A) illuminated? → Press LOCK button on the front panel several times to unlock the VCR. • Is a cassette inserted? • Has the tape run out?
Noise bars in the picture during playback.	→ Adjust the tracking by pressing TRACKING buttons on the front panel.
Playback speed is fast or slow.	→ Adjust the playback speed by pressing REC/PLAY MODE buttons on the front panel.
The picture vibrates at the top and bottom when in still picture mode.	→ Adjust the picture by pressing VERTICAL ADJUST buttons on the front panel.
Clear camera pictures during recording but during playback the picture is not clear.	<ul style="list-style-type: none"> • The video heads may be clogged. → Eject the cassette, insert it again and wait for more than 5 seconds. Repeat this step for 4 to 5 times. If this does not correct the problem, contact your dealer.

Warning Display

Self-diagnostic function

This VCR uses a self-diagnostic function to detect an internal malfunction during recording. When a malfunction occurs in the VCR during recording, the indicator corresponding to each malfunction illuminates on the fluorescent display and/or on screen.

The type of malfunction corresponding to the indicator and countermeasures are given below.

Fluorescent display	Monitor	Cause	Remedy	To turn off the indicator
End	TAPE END	The tape ends during recording.	Rewind the tape or press the EJECT button.	Turn off the indicator on the fluorescent display and screen by pressing the EJECT button or rewinding the tape.
noSIG	NO SIGNAL	Lack of video signal input during recording.	Check for loose connections.	When a video signal is restored or the recording mode is cleared, the indicator on the fluorescent display and screen turns off.
(the display starts flashing)	CHECK	Tape/deck trouble during recording.	First, check the cassette. If there seems to be nothing wrong with the cassette, try the recording operation again. If the indicator "CHECK" is still displayed on the monitor, replace the cassette with a new one and try the operation again. If this does not clear the indicator, unplug the power cord and contact your dealer.	
CLOg (for 168-hour model only)	—	Clogged head during recording at 120H-224H or 0H (except for 128H) mode.	Eject the cassette, insert it again, and wait for more than 5 seconds. Repeat this step for 4 to 5 times. Try recording again. If the indicator "CLOg" still appears, please consult your dealer.	When the recording mode is cleared, the indicator on the fluorescent display on screen turns off.

■ When the tape ends

When the tape reaches its end during recording, "End" illuminates on the fluorescent display and "TAPE END" illuminates on screen. The warning indicators will not illuminate, if TAPE END in FIRST TIME SET UP menu is set to REPEAT, ALARM•PROT (when no alarm recording is made), or REWIND.

■ Lack of video signal input

The indicator "NO SIGNAL" appears on screen and "noSig" flashes on the fluorescent display when the VCR cannot get any video input signal during recording. The video input signal will not be obtained in case of any malfunction such as a broken video cable or POWER to the camera is turned off.

■ Head Clog (for 168-hour model only)

When CLOG DETECT of the RECORDING SET UP menu is set to ON, the VCR automatically removes any particles that may accumulate on the heads during the recording at 120H-224H or 0H (except for 128H) mode. If it cannot be entirely removed, "CLOg" flashes on the fluorescent display. If so, follow the remedy of "CLOg" in the above chart.

Control Input/Output Signals and Circuit

ALM/RST/REC IN terminals (screw)

Active : When input terminals are short-circuited to GND or "L" level voltage (0 to +1.6 V) applied.
 Time for active : 0.1 sec. or over.
 Non active : Open the input.

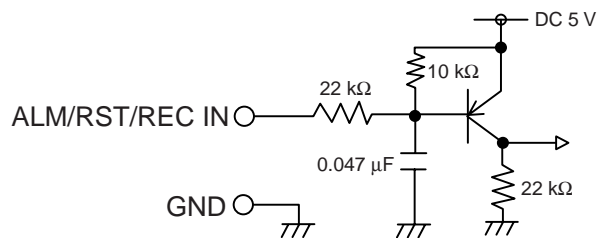

<Interface circuit inside the VCR>

ALM/MODE/CALL OUT terminals (screw)

Active : "L" level voltage (0 to +0.4 V) output; max. drive current 50 mA (+5 V DC)/10 mA (+24 V DC)
 Non active : Open; max. voltage +24 V DC

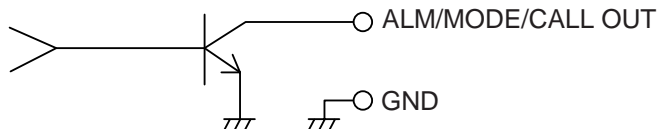

<Interface circuit inside the VCR>

CLK OUT terminals (screw)

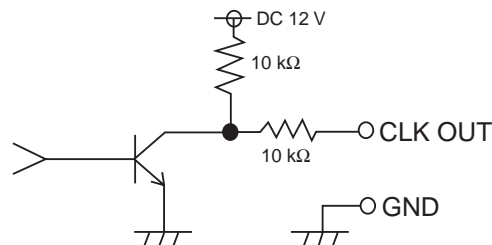

<Interface circuit inside the VCR>

CLK OUT signal

- When F is selected in CLOCK OUT of REAR TERMINAL menu (at 6H or 8H mode) or while recording in L18H-224H or 0H mode.
- When REC-1 to REC-60 is selected in CLOCK OUT of REAR TERMINAL menu (at 6H or 8H mode).

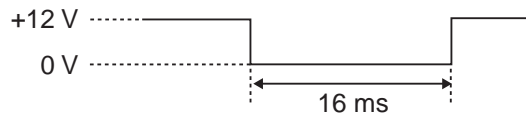
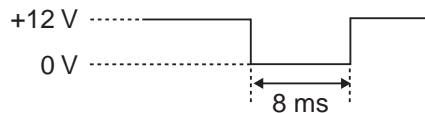

Specifications

General

Power Source	: AC 100-230 V ± 10%, 50/60 Hz (The included power cord is used for 120 V, 60 Hz.)
Power Consumption	: Approx. 20 watts
Television System	: EIA standard 525 lines, 60 field NTSC-type color system
Color Signal	: Low frequency conversion, sub-carrier phase shift recording
Tape Format	: VHS 1/2" width high-density video cassette tape
Tape Speed and Recording	: See below (*1)
Fast Forward/Rewind Time	: Approx. 120 seconds with T-120 tape
Operating Temperature	: 41 °F to 104 °F (5 °C to 40 °C)
Relative Humidity	: Max. 80 %
Dimensions (Jog dial included)	: 16.7 (W) x 12.3 (D) x 3.7 (H) (in.) 425 (W) x 313 (D) x 95 (H) (mm)
Weight	: 9.7 lbs (4.4 kg)
Heads-Video	: 4 rotary heads
Luminance Signal	: Frequency modulation recording
Audio Track	: 1 track
Audio/Control	: 1 stationary head
Erase	: 1 full-track head
Motors	: 3 motors-drum/capstan direct drive system
Battery Backup	: Lasts 31 days

Audio

Input <Line In>	: 308 mV (rms), 50 kΩ, RCA plug
Input <MIC In>	: 0.346 mV (rms), 600 Ω, mini jack
Output	: 388 mV (rms), 1 kΩ, RCA plug
Signal-to-Noise Ratio	: Better than 43 dB
Frequency Response	: 70 Hz - 4 kHz (6H mode)

Video

Input	: 1.0 V (p-p), 75 Ω, BNC plug
Output <Rear>	: 1.0 V (p-p), 75 Ω, BNC plug
Output <Front>	: 1.0 V (p-p), 75 Ω, RCA plug
Signal-to-Noise Ratio	: Better than 42 dB
Horizontal Resolution	: More than 400 lines (Super Resolution mode) More than 240 lines (VHS mode)

Connectors

ALM Input	: Screw terminal for starting alarm recording
RST Input	: Screw terminal for finishing alarm recording or for adjusting on-screen clock
REC Input	: Screw terminal for starting/finishing recording or for series recording
GND	: Screw terminal for ground
ALM Output	: Screw terminal for output while alarm recording is under way
CLK Output	: Screw terminal to command camera switching
MODE Output	: Screw terminal for indication of VCR selected mode
CALL Output	: Screw terminal for external warning device or for series recording
REMOTE Jack	: Jack for connecting the remote control unit
RS-232C Interface	: D-SUB 9 pin connector

Weight and dimensions shown are approximate.

Design and specifications are subject to change without notice.

(*1)

Tape Speed and Recording Time for 96-hour model:

T-120		T-160		Speed (mm/s)	Recording Interval (s/field)	Recording Fields per Second (fields/s)	Video Signal	Audio Signal	Tape Drive
Mode	Time (hour:minute)	Mode	Time (hour:minute)						
6H (EP)	6:00	8H (EP)	8:00	11.12	0.0167	60	Continuous	Recordable	Continuous
L18H (EP)	18:00	L24H (EP)	24:00	3.71	0.050	20	Time Lapse	Recordable	Continuous (Slow)
L30H (EP)	30:00	L40H (EP)	40:00	2.22	0.083	12	Time Lapse	Recordable	Continuous (Slow)
48H (EP)	54:00	64H (EP)	72:00	–	0.150	6.7	Time Lapse	Not recorded	Time Lapse
72H (EP)	78:00	96H (EP)	104:00	–	0.217	4.6	Time Lapse	Not recorded	Time Lapse
96H (EP)	102:00	128H (EP)	136:00	–	0.284	3.5	Time Lapse	Not recorded	Time Lapse
0H (EP)	–	0H (EP)	–	–	–	–	Time Lapse	Not recorded	Time Lapse

Tape Speed and Recording Time for 168-hour model:

T-120		T-160		Speed (mm/s)	Recording Interval (s/field)	Recording Fields per Second (fields/s)	Video Signal	Audio Signal	Tape Drive
Mode	Time (hour:minute)	Mode	Time (hour:minute)						
6H (EP)	6:00	8H (EP)	8:00	11.12	0.0167	60	Continuous	Recordable	Continuous
L18H (EP)	18:00	L24H (EP)	24:00	3.71	0.050	20	Time Lapse	Recordable	Continuous (Slow)
L30H (EP)	30:00	L40H (EP)	40:00	2.22	0.083	12	Time Lapse	Recordable	Continuous (Slow)
48H (EP)	54:00	64H (EP)	72:00	–	0.150	6.7	Time Lapse	Not recorded	Time Lapse
72H (EP)	78:00	96H (EP)	104:00	–	0.217	4.6	Time Lapse	Not recorded	Time Lapse
96H (EP)	102:00	128H (EP)	136:00	–	0.284	3.5	Time Lapse	Not recorded	Time Lapse
120H (EP)	126:00	160H (EP)	168:00	–	0.350	2.9	Time Lapse	Not recorded	Time Lapse
168H (EP)	174:00	224H (EP)	232:00	–	0.484	2.1	Time Lapse	Not recorded	Time Lapse
0H (EP)	–	0H (EP)	–	–	–	–	Time Lapse	Not recorded	Time Lapse

Note

If the VCR is not working correctly or showing an unusual indication on the fluorescent display, press **RESET** button at the rear panel with a pointed instrument. When pressed, Date/Present time/ALARM LIST/POWER LOSS LIST/Counter display/Recording and Playback mode will be set to the default setting and the VCR turns off.

To restart the VCR, press **POWER** button to turn on the VCR and then set the day and present time.