

HEGS5300 CCTV Control Keyboard

User Manual



| ISSUE | DATE | REVISIONS |
|-------|-----------|-----------------------------|
| A | July 2004 | Initial Release (PCN 1752). |

FCC COMPLIANCE STATEMENT

INFORMATION TO THE USER: This equipment has been tested and found to comply with the limits for a Class A digital device, pursuant to part 15 of the FCC rules. These limits are designed to provide reasonable protection against harmful interference when the equipment is operated in a commercial environment. This equipment generates, uses, and can radiate radio frequency energy and, if not installed and used in accordance with the instruction manual, may cause harmful interference to radio communications. Operation of this equipment in a residential area is likely to cause harmful interference in which case the user will be required to correct the interference at his own expense.

CAUTION: Changes or modifications not expressly approved by the party responsible for compliance could void the user's authority to operate the equipment.

This Class A digital apparatus complies with Canadian ICES-003.

Cet appareil numérique de la Classe A est conforme à la norme NMB-003 du Canada.

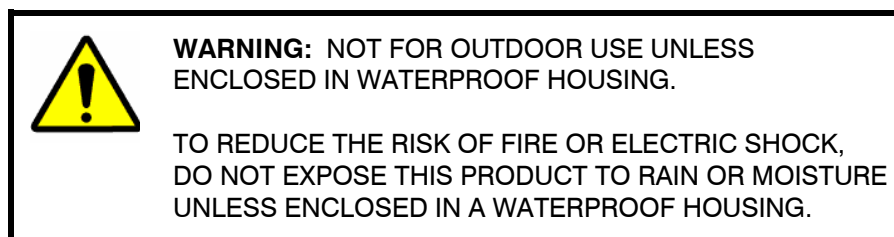
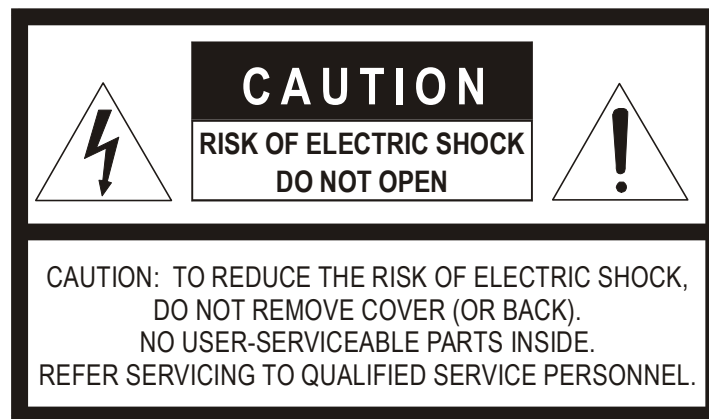

NOTES:

TABLE OF CONTENTS

| | |
|--|----------|
| SECTION 1: INTRODUCTION | 1 |
| 1.1 PRODUCT DESCRIPTION | 1 |
| 1.2 KEYBOARD OVERLAY | 1 |
| 1.3 ICONS | 2 |
| SECTION 2: SETUP AND WIRING | 3 |
| 2.1 SETUP MODE | 3 |
| 2.2 JOYSTICK | 4 |
| 2.3 KEYCODE TABLE | 4 |
| 2.4 WIRING CONNECTIONS | 6 |
| 2.5 CABLE LENGTHS | 6 |

NOTES:

SECTION 1: INTRODUCTION

1.1 PRODUCT DESCRIPTION

The HEGS5300 Keyboard interfaces to the HMXAT200 and supports all power standards. The interface board in the HMXAT200 provides 12VDC at RJ11 connectors 3 and 4 (ports 3 and 4) to power a HEGS5300 keyboard. All keyboards connected to other ports must have their own power supply. All HEGS5300 Keyboard models are shipped with a universal power supply for 110 or 220VAC input to +12VDC output.





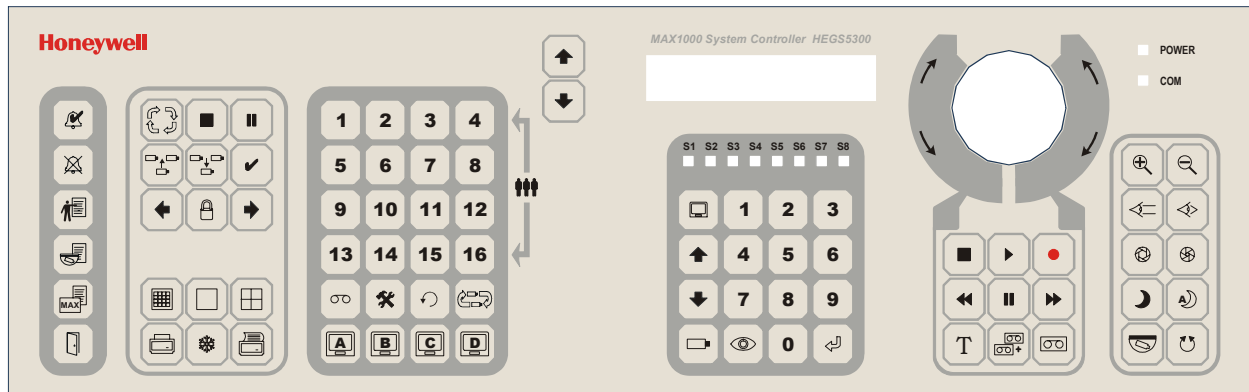













1.2 KEYBOARD OVERLAY

















The illustration below is the standard default overlay on a HEGS5300 keyboard. Overlays are exchangeable and can be customized so they may vary from site to site.





































1.3 ICONS

The following icons and their descriptions may or may not be on your specific controller.

| | |
|---|-------------------|
|  | Camera |
|  | Monitor |
|  | Dome / PTZ |
|  | Iris Open |
|  | Iris Close |
|  | Focus Far |
|  | Focus Near |
|  | Zoom Out (wide) |
|  | Zoom In (tele) |
|  | View / Preshot |
|  | Alarm Acknowledge |
|  | Alarm Clear |
|  | User Macro |
|  | Dome Macro |
|  | Maxpro Menu |
|  | Door Open |
|  | Clear |
|  | Aux |

| | |
|---|---------------------|
|  | Video Recorder |
|  | Play |
|  | Reverse Play |
|  | Record |
|  | Stop |
|  | Pause |
|  | Frame Forward |
|  | Frame Back |
|  | Rewind |
|  | Fast Forward |
|  | Counter Reset |
|  | Counter Memory Stop |
|  | Time Mode |
|  | Time Date Search |
|  | Index Search |
|  | Next |
|  | Previous |
| | |

| | |
|---|--------------------|
|  | Multiplexer |
|  | Freeze |
|  | Multiplexer Zoom |
|  | Multiplexer Cursor |
|  | Full Screen |
|  | Picture in picture |
|  | 2 x 2 Display |
|  | 3 x 3 Display |
|  | 4 x 4 Display |
|  | Live Record |
|  | Sequence |
|  | Enter |
|  | Last / Undo |
|  | Select Monitor A |
|  | Select Monitor B |
|  | Select Monitor C |
|  | Select Monitor D |
| | |

| | |
|---|-------------------------|
|  | Scan Select |
|  | Insert camera into scan |
|  | Delete camera from scan |
|  | Lock Scan |
|  | Previous Step in Scan |
|  | Next Step in Scan |
|  | Alternate Camera |
|  | Set |
|  | Group |
|  | Night Shot |
|  | Auto Exposure |
|  | Dub |
|  | Review |
|  | Printer Select |
|  | Print |
|  | Text |
|  | Function |
| | |

SECTION 2: SETUP AND WIRING



2.1 SETUP MODE

HEGS5300 keyboards are setup using the keyboard keys. There are three user-defined settings.



1. **Keyboard ID** – valid ID's 1 to 99. (Default = ID 1).
2. **Baud Rate** – 19K2 or 9600.
(Default = 19K2. Data format is fixed at 7 data bits, 1 stop bit, even parity).
3. **Joystick speed range** – There are 2 ranges of pan/tilt speeds from the analog joystick.

The default is a range of 5 speeds (0=STOP to 5=Maximum speed). Speed 5 is generated when the joystick is at its maximum pan or tilt position.

The second range is from 0 to 26. As before, 0=STOP and the speeds generated are from A (slowest) through Z (fastest). Speed Z is equivalent to speed 5 in that it is generated when the joystick is at its maximum pan or tilt position. This feature is available when using MAX1000, version 4.27 or later.

To enter the SETUP MODE hold down the MENU key  or the  key (to the left-of the LCD) as the keyboard is powered up.

NOTE: If the keyboard has a custom overlay, the MENU key may be located in a different position. Therefore, the  key next to the LCD is always the preferred option.

In SETUP MODE, the LCD guides the user in entering required information using the numeric keypad. Press the Enter key () or the  key to the next screen. Press the  key to return to the previous setup screen.

When the keyboard ID, baud rate, and joystick speed range have been entered, the final setup stage stores the settings and the joystick reference position. The keyboard should be flat on the desk when pressing the enter key () at this final stage to ensure the joystick is zeroed. Setup information is stored in non-volatile memory so the settings will be retained if the keyboard is unplugged.

2.2 JOYSTICK

The HEGS5300 keyboard is equipped with a 3-dimensional joystick which allows zoom-in and zoom-out functions to be performed by twisting the top of the joystick either clockwise (zoom-in) or counterclockwise (zoom-out). The “ZOOM IN” and “ZOOM-OUT” buttons located on the keyboard still operate as normal.

2.3 KEYCODE TABLE

| Keycode | Key Name | Command |
|---------|-----------------|-------------|
| #001 | ALARM ACK | |
| #002 | | |
| #003 | SCAN | S |
| #004 | HALT | H |
| #005 | PAUSE | P |
| #006 | | |
| #007 | Logical Group 1 | |
| #008 | Logical Group 2 | |
| #009 | Logical Group 3 | |
| #010 | Logical Group 4 | |
| #011 | ALARM CLEAR | A |
| #012 | | |
| #013 | SCAN INSERT | I |
| #014 | SCAN DELETE | D |
| #015 | SET KEY | T |
| #016 | | |
| #017 | Logical Group 5 | |
| #018 | Logical Group 6 | |
| #019 | Logical Group 7 | |
| #020 | Logical Group 8 | |
| #021 | USER MACRO | U |
| #022 | | |
| #023 | LEFT ARROW | < |
| #024 | LOCK KEY | |
| #025 | RIGHT ARROW | > |

| Keycode | Key Name | Command |
|---------|------------------|----------|
| #026 | | |
| #027 | Logical Group 9 | |
| #028 | Logical Group 10 | |
| #029 | Logical Group 11 | |
| #030 | Logical Group 12 | |
| #031 | DOME MENU | |
| #032 | | |
| #033 | | |
| #034 | | |
| #035 | | |
| #036 | | |
| #037 | Logical Group 13 | |
| #038 | Logical Group 14 | |
| #039 | Logical Group 15 | |
| #040 | Logical Group 16 | |
| #041 | MAX MENU | ? |
| #042 | | |
| #043 | MULTIPLEXER | Q |
| #044 | FULL SCREEN | |
| #045 | MULTISCREEN | |
| #046 | | |
| #047 | VCR KEY | R |
| #048 | FUNCTION KEY | |
| #049 | UNDO | |
| #050 | ALTERNATE | |

2.3 KEYCODE TABLE, CONTINUED

| Keycode | Key Name | Command |
|---------|--------------|----------|
| #051 | DOOR OPEN | |
| #052 | | |
| #053 | PRINT SELECT | |
| #054 | PRINT FREEZE | |
| #055 | COLOR PRINT | |
| #056 | B/W PRINT | |
| #057 | MON A | |
| #058 | MON B | |
| #059 | MON C | |
| #060 | MON D | |
| #061 | <MON> | M |
| #062 | <1> | 1 |
| #063 | <2> | 2 |
| #064 | <3> | 3 |
| #065 | [up-arrow] | + |
| #066 | <4> | 4 |
| #067 | <5> | 5 |
| #068 | <6> | 6 |
| #069 | [down-arr] | - |
| #070 | <7> | 7 |
| #071 | <8> | 8 |
| #072 | <9> | 9 |
| #073 | <CAM> | C |
| #074 | <VIEW> | V |
| #075 | <0> | 0 |
| #076 | <ENTER> | . |

| Keycode | Key Name | Command |
|---------|---------------|----------|
| #077 | [vcr-stop] | s |
| #078 | [vcr-play] | p |
| #079 | [vcr-record] | r |
| #080 | [vcr-rewind] | w |
| #081 | [vcr-pause] | u |
| #082 | [vcr-forward] | f |
| #083 | TEXT | B |
| #084 | DUB | |
| #085 | REVIEW | |
| #086 | [zoom-in] | G |
| #087 | [zoom-out] | H |
| #088 | [focus-far] | B |
| #089 | [focus-near] | A |
| #090 | [iris-open] | I |
| #091 | [iris-close] | E |
| #092 | NIGHT SHOT | |
| #093 | AUTO EXPOSURE | |
| #094 | CALL PTZ | X |
| #095 | PTZ TOUR | |
| #096 | [tilt-up] | K |
| #097 | [tilt-down] | j |
| #098 | [pan-left] | d |
| #099 | [pan-right] | c |
| #100 | [scroll-up] | |
| #101 | [scroll-down] | |
| #102 | PTZ aux | x |

2.4 WIRING CONNECTIONS

| RJ11 Socket on rear of keyboard | RJ11 Socket on rear of HMXAT200 |
|---------------------------------|---------------------------------|
| Pin 1 – Power GND | Pin 6 – Power GND |
| Pin 2 – TX Data | Pin 5 – RX Data |
| Pin 3 – Signal GND | Pin 4 – Signal GND |
| Pin 4 – RX Data | Pin 3 – TX Data |
| Pin 5 – N/C | Pin 2 – N/C |
| Pin 6 – 12Vdc | Pin 1 – 12Vdc |

RJ11 Socket on Keyboard

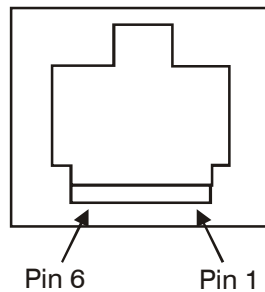

RJ Leads for Connecting Keyboards

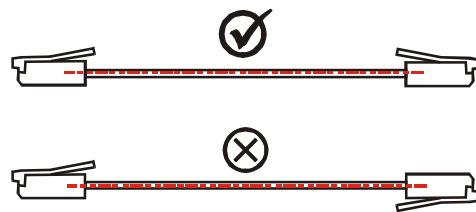

2.5 CABLE LENGTHS

Refer to the following illustrations for examples of wiring connections.

NOTE: The HEGS5300 CCTV Keyboard is supplied with a standard 7-foot flat telephone cable. It is strongly recommended that twisted-pair data cable is used from the RJ11 Termination Box when long cable lengths are required to eliminate any data problems. Any cable length in excess of RS232 standards (50 feet) requires line driver units (model number PTE102).

Example 1

7-FOOT FLAT TELEPHONE CABLE
(PROVIDED WITH HEGS5300)

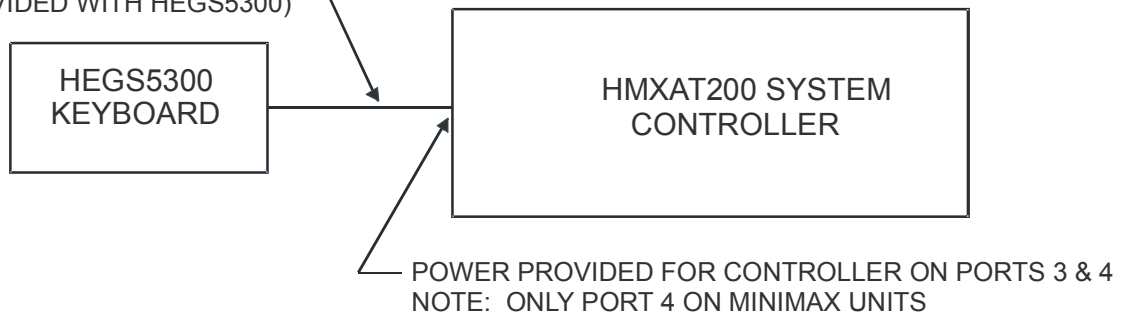

2.5 CABLE LENGTHS, CONTINUED

Example 2

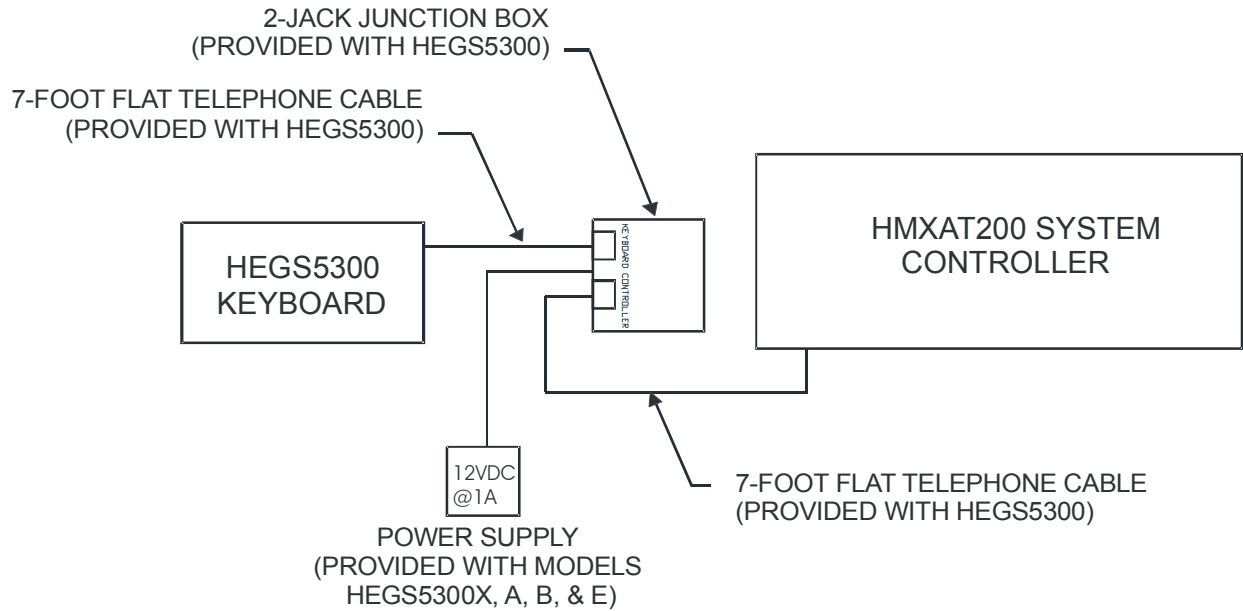

Example 3

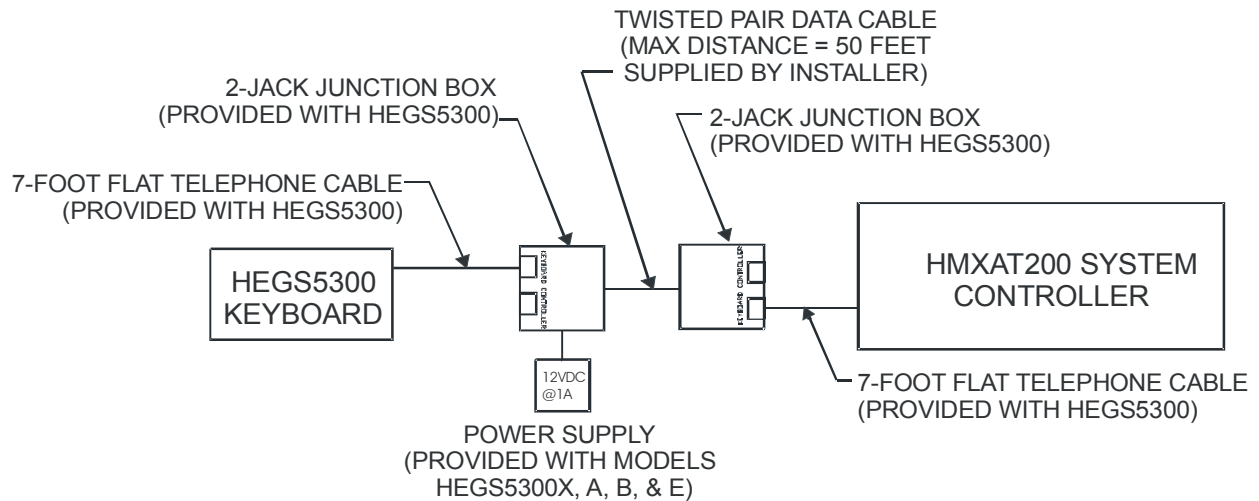

2.5 CABLE LENGTHS, CONTINUED

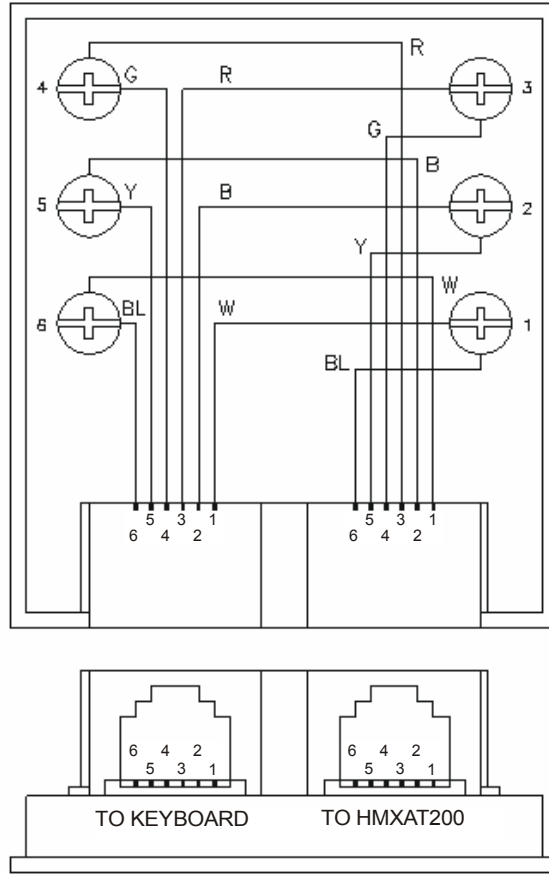

| KEYBOARD RJ11 CONNECTOR | | |
|-------------------------|--------|----------|
| PIN 1 | WHITE | 12V |
| PIN 2 | BLACK | NC |
| PIN 3 | RED | Tx |
| PIN 4 | GREEN | SIG. GND |
| PIN 5 | YELLOW | Rx |
| PIN 6 | BLUE | PWR GND |

| HMXAT200 RJ11 CONNECTOR | | |
|-------------------------|--------|----------|
| PIN 1 | WHITE | PWR GND |
| PIN 2 | BLACK | Tx |
| PIN 3 | RED | SIG. GND |
| PIN 4 | GREEN | Rx |
| PIN 5 | YELLOW | NC |
| PIN 6 | BLUE | 12V |

**Figure 1: MAX1000 Keyboard RJ11 Two-Way Junction Box (0365-0009)
Drawing MG10075**

2.5 CABLE LENGTHS, CONTINUED

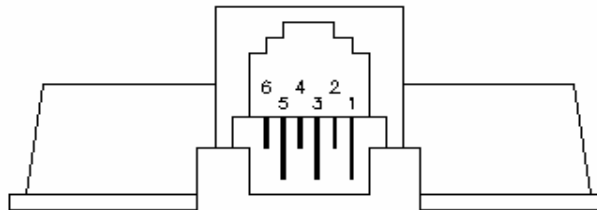
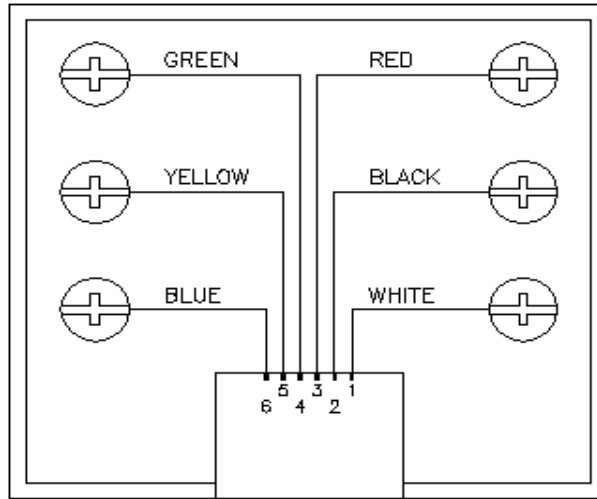

| RJ12 | | | D15 | |
|-------|--------|----------|--------|----------|
| PIN 1 | WHITE | 12V | PIN 8 | 12V |
| PIN 2 | BLACK | NC | PIN 3 | NC |
| PIN 3 | RED | Tx | PIN 3 | Tx |
| PIN 4 | GREEN | SIG. GND | PIN 5 | SIG. GND |
| PIN 5 | YELLOW | Rx | PIN 2 | Rx |
| PIN 6 | BLUE | PWR GND | PIN 15 | PWR GND |

Figure 2: MAX1000 Keyboard RJ12 Terminal Box Pin Utilization Drawing MG10023

Honeywell

Video Systems

www.honeywellvideo.com

1-800-796-CCTV

© 2004 Honeywell International Inc.

All rights reserved. No part of this publication may be reproduced by any means without written permission from Honeywell Video Systems. The information in this publication is believed to be accurate in all respects. However, Honeywell Video Systems cannot assume responsibility for any consequences resulting from the use thereof. The information contained herein is subject to change without notice. Revisions or new editions to this publication may be issued to incorporate such changes.